

FAG

FAG SPLIT PLUMMER BLOCK HOUSINGS OF SERIES SNV



for shaft diameters of 20 to 160 mm and $\frac{3}{4}$ to $5\frac{1}{2}$ inches

FAG Split Plummer Block Housings of Series SNV
for shaft diameters of 20 to 160 mm and $\frac{3}{4}$ to $5\frac{1}{2}$ inches

Publ. No. WL 90 118/4 EA

FAG Kugelfischer AG & Co. KG

Industrial Bearings and Services

Postfach 1260 · D-97419 Schweinfurt

Telefon +49 9721 91-0 · Telefax +49 9721 91-3435

E-mail: gehaeuse_k@fag.de

www.fag.de

Preface

The Business Unit Industrial Bearings and Services of the FAG Kugelfischer Georg Schäfer AG Group supplies rolling bearings, necessary accessories, and services to original equipment customers in machinery and plant construction as well as to customers in the distribution and spare parts business. Comprehensive rolling bearing know-how, competent consultation on applications, and extensive customer service for more operational reliability make FAG an indispensable partner to its customers. Development

and further development of our products is based on the requirements of operation in the field. An ideal outline of requirements is best achieved through cooperation of our application engineers with the manufacturers and operators of machinery. It forms the basis for successful solutions both technically and economically speaking.



Contents

Split FAG plummer block housings of series SNV	3
Dimensions, material	4
Bearing seat and bearing mounting ...	4
Seals and covers	4
Lubrication	6
Mounting instructions	12
Additional holes for fastening bolts and pins	16
Loadability	16
Codes, Ordering examples	18
Dimensional tables	20

Split plummer block housings of series SNV

The FAG split plummer block housings of series SNV, fig. 1 were designed according to the modular system and developed on the basis of the SN/SNE housings. Rolling bearings of diverse diameter and width series can be mounted in any SNV housing if they have an outside diameter suitable for the housing, fig. 2.

Suitable bearing types are, for example, self-aligning ball bearings, barrel roller bearings, split and unsplit spherical roller bearings and deep groove ball bearings.

The bearings are either directly seated on the shaft or fixed with adapter sleeves. This results in different shaft diameters

for the same bearing size. Corresponding seals compensate for the gaps between the shaft and the housing passage.

FAG supplies split plummer block housings of series SNV for shafts with diameters from 20 to 160 mm and for $\frac{3}{4}$ to $5\frac{1}{2}$ inches.

The numbers in the housing codes indicate the housing bore and therefore the outside diameter of the suitable bearing e.g. 100 mm in the case of SNV100.

The main advantages of the SNV housing are:

- Easier stock-keeping due to the modular design. One housing size is suitable for different shaft diameters.
- High loadability.
- Depending on operating conditions two-lip seals, labyrinth seals, felt seals, V-ring seals or combined seals can be

used. Special seals are available upon request.

- Centered locating bearings by means of two locating rings of identical width.
- Plane faces at housing base allow the housing to be secured with stops if high forces do not act vertically on the housing support surface.
- Holes can be drilled at spots marked on the housing for: lubricating and monitoring systems, fastening bolts, straight or tapered pins.
- Universal coating of all outer surfaces of the housing which are not machined (colour RAL 7031, blue-grey). The paint can be coated with all synthetic resin, polyurethane, acrylic, epoxy resin, chlorine rubber, cellulose, and acid-hardening hammer dimple enamels.

1: Split plummer block housing of series SNV

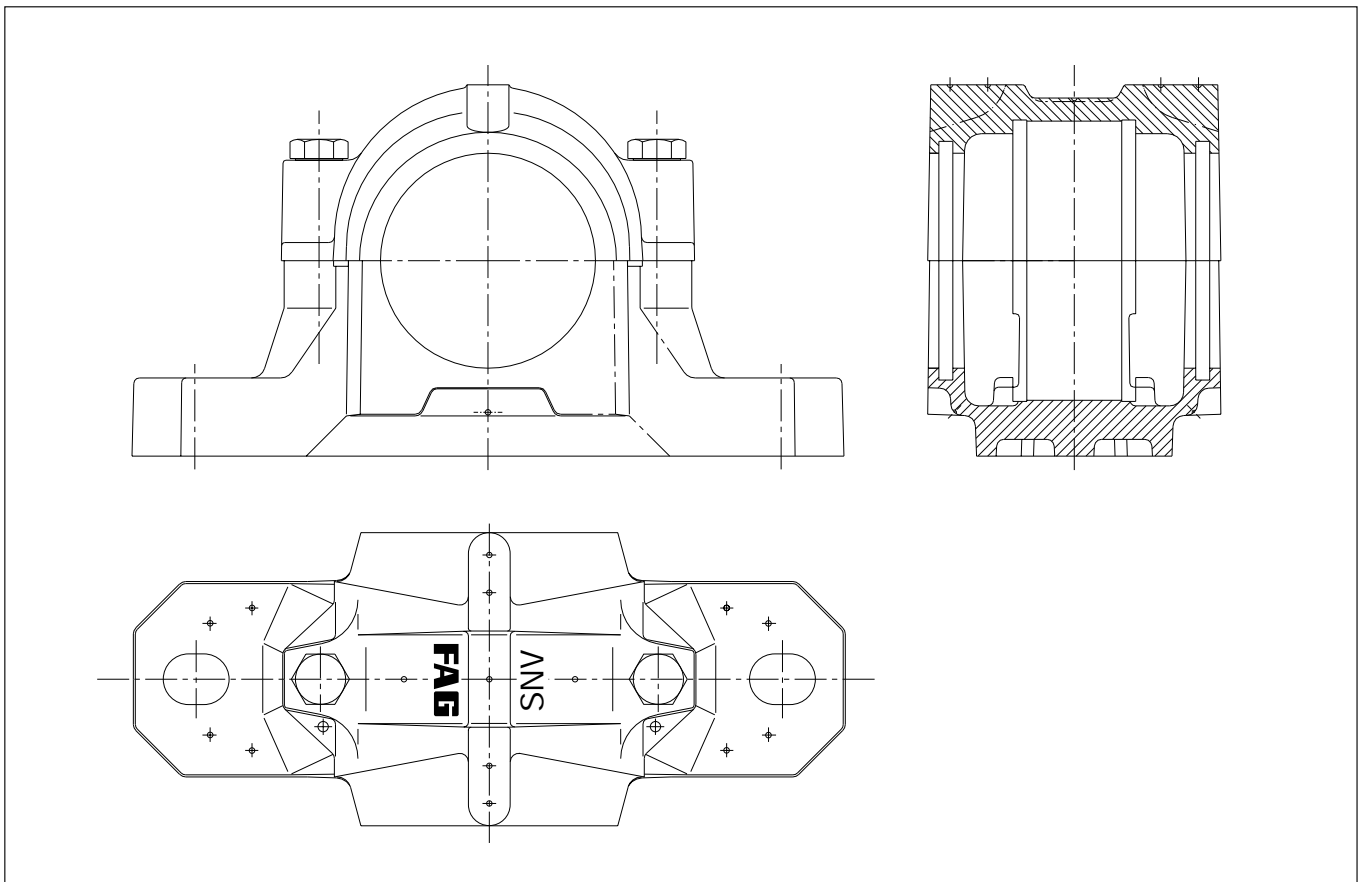

Dimensions, material

The dimensions of the FAG housings of series SNV correspond to ISO 113 and DIN 736 to DIN 739.

The SNV housings are interchangeable with the former SN/SNE housings.

The SNV housings are made of cast iron, material EN-GJL-HB215. Their loadability is considerably higher than that of the SN/SNE housings (see "Loadability" section).

For particularly high stresses nodular cast iron, material EN-GJS-400-15, may also be used (please inquire about availability).

Bearing seat and bearing mounting

The bearing seat in the SNV housing is machined to H7 (applies to condition on supply, i.e. prior to loosening the connecting bolts of upper and lower part). The bearings can be displaced thus acting as floating bearings. Locating bearings are obtained by inserting two FRM locating rings, one on each bearing side. The bearing is then in the centre of the housing.

Rolling bearings which are seated directly on a stepped shaft or with an adapter sleeve on a straight shaft can be fitted into SNV housings, fig. 2.

A diameter tolerance of the shaft according to h8 (h9) is permissible when fastening with adapter sleeve.

Seals and covers

Seals and covers fit into the annular grooves, with rectangular profile, on both sides of the SNV housings.

The DH two-lip seal is usually used. FAG also supplies upon request DHV V-ring seals, TSV labyrinth seals, FSV felt seals, TCV combined seals and special seals. The seals must be specified in the order. They are especially suitable for grease lubrication, see "Lubrication" section.

The FAG two-lip seal DH made of acrylonitrile-butadiene rubber (NBR), fig. 3a, is suitable for circumferential velocities of up to 13 m/s. The two-piece seal can be easily inserted into the annular groove of the housing (observe the position of separating joint).

2: The SNV housings are suitable for bearings with diverse diameter and width series which have the same outside diameter, e.g. 100 mm in the case of SNV100 (2a). Formerly four housing sizes were required for the shaft diameters indicated (2b).

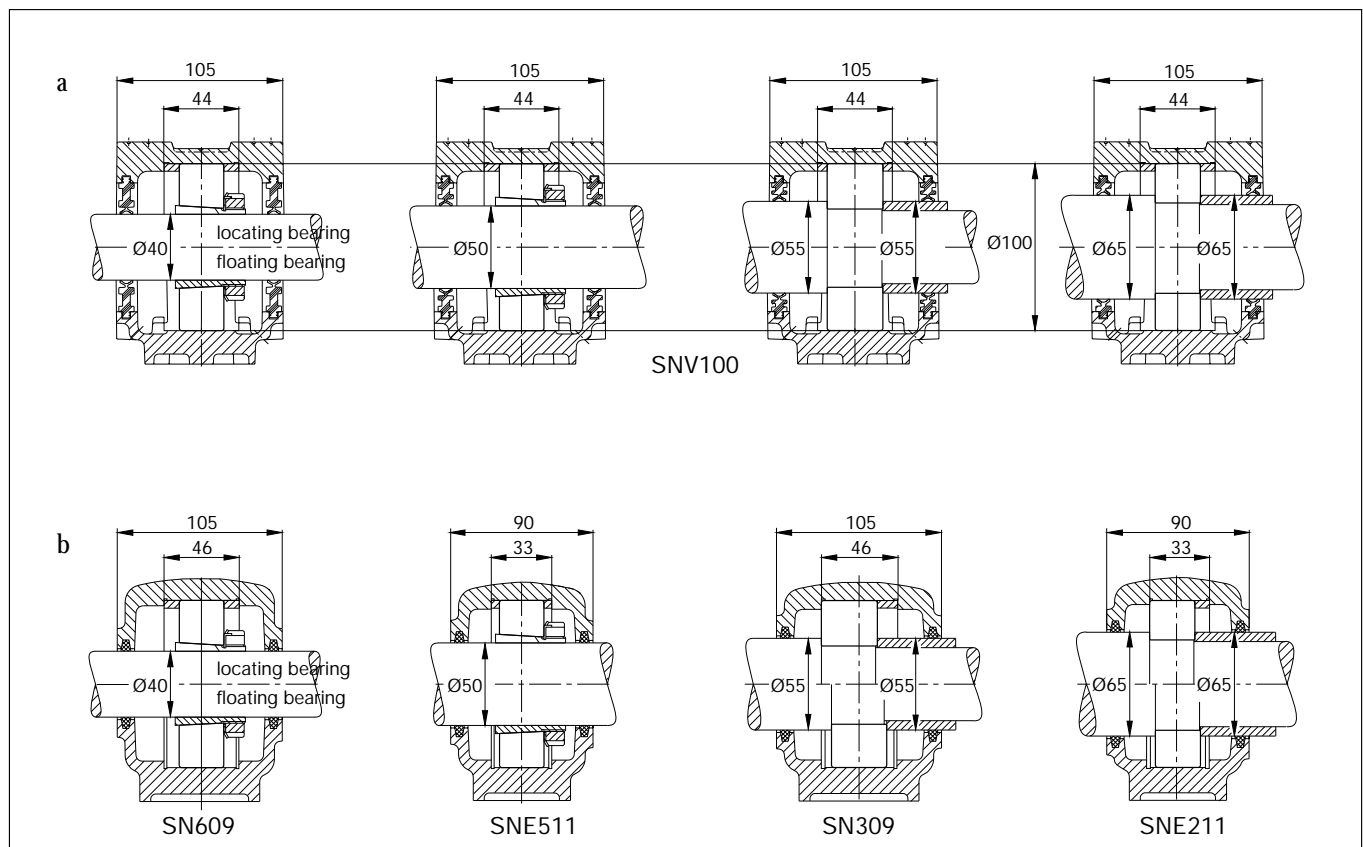

The sealing lips slide on the rotating shaft. The outer sealing lip prevents the penetration of dirt into the bearing. This is also supported by the grease filled between the two lips during mounting. The inner lip prevents the escape of grease from the housing. The two-lip seal permits shaft inclinations of up to 0.5° in both directions. It is suitable for temperatures between -40°C and $+100^\circ\text{C}$. At the contact area of the sealing lips the roughness of the shaft should correspond to class N8 (DIN ISO 1302).

The sealing lip of FAG DHV V-ring seals made of NBR axially abuts the sliding surface, Fig. 3b. The seal permits inclinations of 0.5° in both directions and, with grease lubrication, is suitable for circumferential velocities of up to 12 m/s (for velocities >8 m/s the seal must be

fixed axially, for velocities >12 m/s the seal must in addition be clamped radially).

FAG FSV felt seals, fig. 3c, are suitable for grease lubrication and temperatures up to 100°C (aramide packages for higher temperatures available upon request). The adapter with the felt strip, which is previously soaked in oil, is secured in the housing groove and is prevented from rotating by an O-ring. Felt seals are suitable for circumferential velocities of up to 5 m/s and, after the running-in phase, up to 15 m/s. The permissible shaft inclination is in both directions.

FAG labyrinth rings of the series TSV, fig. 3d, are also suitable for higher circumferential velocities since they are non-rubbing. The O ring which is pressed in

between the shaft and labyrinth ring ensures that the labyrinth ring does not slip despite its loose fit. The O ring, which is made of fluoro-caoutchouc (Viton[®]), is suitable for temperatures up to 200°C . The labyrinth seal accepts shaft inclinations of up to 0.5° in both directions. The labyrinth can be relubricated at position 1 and 5, fig. 4, if required.

Seals made up of a combination of labyrinth seal and V ring (TCV), fig. 3e, are available upon request.

If the SNV housings are to be closed on one side, the DKV covers, fig. 3f, have to be ordered separately. The synthetic covers are suitable for long-term operation at temperatures up to 120°C . DKVT covers for higher temperatures, fig. 3g, are available upon request.

3: Seals and covers for SNV housings

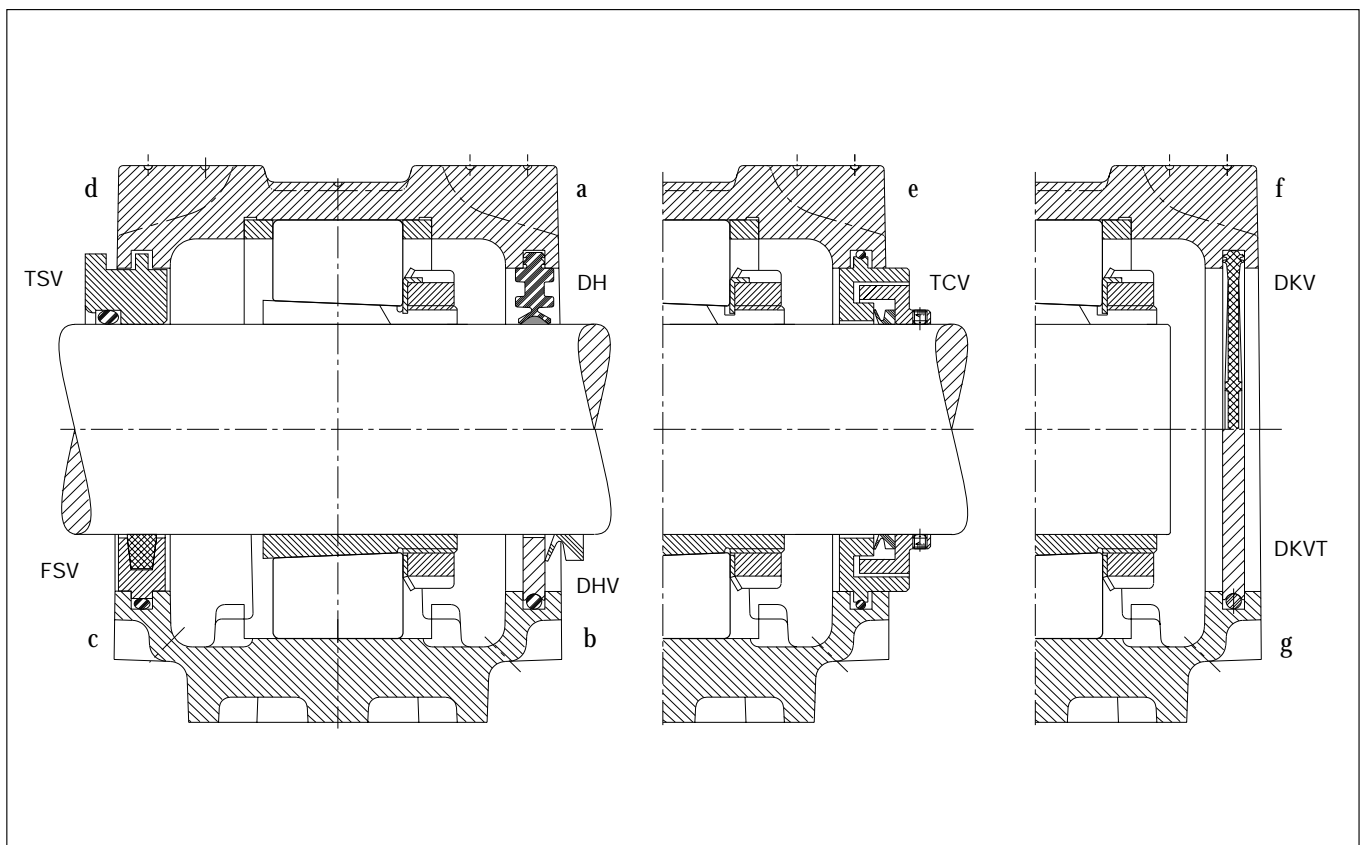

Lubrication

Lubrication

Grease lubrication

In many cases, the bearings can be greased for-life, i.e. the initial grease fill (see fig. 5 for initial grease fill amounts) will last for the entire bearing life if using rubbing seals (e.g. DH, FSV). The bearings are packed to capacity with grease and 60% of the housing cavities is filled.

The FAG rolling bearing grease Arcanol MULTITOP, a lithium soap base grease of the NLGI class 2 with particularly effective EP additives is especially suitable (see FAG Publ. No. WL 81 116 also) for bearing operating temperatures $< 100^{\circ}\text{C}$, bearing loads $P/C < 0.3$ and a bearing-related speed index $k_a \cdot n \cdot d_m < 700\,000 \text{ min}^{-1} \cdot \text{mm}$ ($k_a = 1$ for self-aligning ball bearings and deep groove ball bearings, $k_a = 2$ for spherical roller bearings).

In the case of a speed index $n \cdot d_m < 50\,000 \text{ min}^{-1} \cdot \text{mm}$ and non-rubbing sealing (e.g. TSV), where the grease also has to function as a seal, the housing and sealing cavities may be packed to capacity.

Grease change

A change of grease for new grease should be undertaken if the attainable fatigue life of the bearing is considerably longer than the grease service life (to be found in FAG Publ. No. WL 81 115 „Rolling Bearing Lubrication“).

Grease relubrication

Grease outlet hole

If, in isolated cases, the grease exchange intervals are too short, relubrication is recommended. The lubricant can be supplied to the housing laterally or where bearings with lubricating groove and holes are used also centrally. In the case of lateral lubrication the housing cavities on the side of the grease nipple

must be filled to about 100% so that the replenished grease reaches the bearing immediately. Depending on the seal type selected and on the application in question, the housing top can be provided with grease nipples for lubricant supply at positions 2 or 4, fig. 4, and on the opposite side of the housing base the grease outlet hole can be provided (an absolute must for DH seals).

The grease nipple and outlet hole are specified in the order by adding the suffix G944A* to the housing code. Please refer

to fig. 6 for the location and dimensions of the holes and the grease nipple.

The far right column of fig. 5 indicates the minimum relubrication quantities. It is not possible to overgrease the bearings if there is a grease outlet hole or non rubbing sealing. The temperature may rise due to the working of the replenished grease. It will drop to its original level after a few running hours when the surplus grease has been expelled. In the interest of the environment it is recommended to dose the lubricant.

4: Markings at the housing top for grease nipple connecting holes

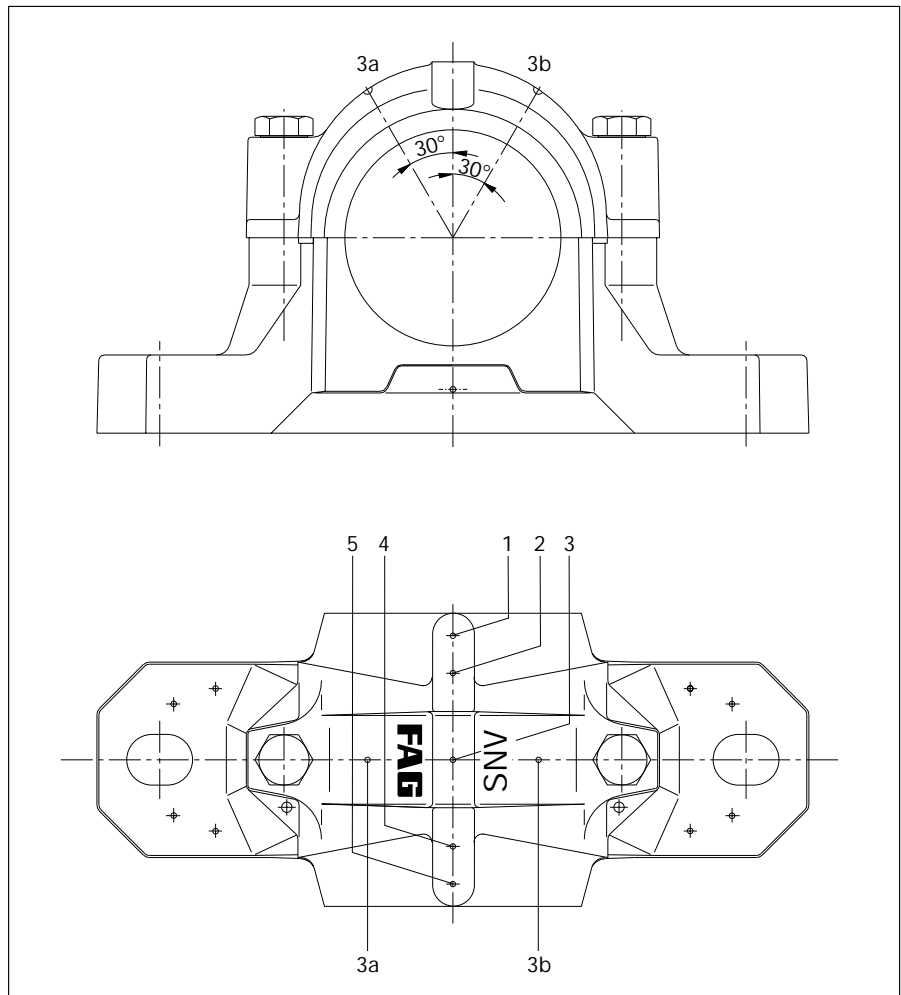

Due to their good flow behaviour, greases of consistency class 2, e.g. Arcanol MULTITOP and MULTI2, are more suitable for replenishment than greases of higher consistency classes.

5: Recommended grease quantities for the initial grease fill (housing cavities 60%, bearings packed to capacity) and the relubrication of SNV housings

Housing	Grease quantity	
	Initial fill g	Re-lubrication
FAG		
SNV052	30	5
SNV062	45	5
SNV072	65	10
SNV080	80	10
SNV085	105	10
SNV090	130	10
SNV100	180	15
SNV110	210	15
SNV120	270	20
SNV125	290	20
SNV130	330	20
SNV140	440	25
SNV150	500	30
SNV160	650	40
SNV170	700	45
SNV180	900	55
SNV190	950	60
SNV200	1200	70
SNV215	1400	80
SNV230	1600	85
SNV240	1700	90
SNV250	2000	100
SNV260	2000	120
SNV270	2500	130
SNV280	2600	140
SNV290	3000	150
SNV300	3100	160
SNV320	3700	200
SNV340	4500	240

6: Dimensions recommended for grease nipple connecting holes and grease outlet holes

SNV housings for grease replenishment (suffix G944AA* supply on request) are equipped with a grease nipple and an outlet hole of the sizes shown in the table.
Example: Design G944AA with conical grease nipple NIP.DIN71412-AM10x1.

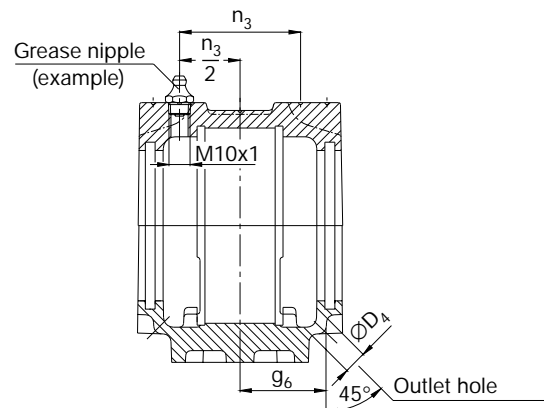

Housing	Connection for grease nipple	Grease outlet hole	
	n_3 mm	D_4 mm	g_6 mm
FAG	mm	mm	
SNV052	19	10	27.5
SNV062	21	10	30
SNV072	23	10	33
SNV080	26	10	36
SNV085	23.5	10	34.5
SNV090	29	10	41.5
SNV100	31	15	44
SNV110	33.5	15	46
SNV120	35.5	15	49
SNV125	28.5	10	41
SNV130	38	15	51.5
SNV140	40.5	15	57.5
SNV150	42.5	15	60
SNV160	45	15	62.5
SNV170	46.5	20	64
SNV180	49.5	20	69
SNV190	49.5	20	68.5
SNV200	55.5	20	77.5
SNV215	58.5	20	80
SNV230	61	20	83
SNV240	60	20	81.5
SNV250	65.5	20	89
SNV260	62.5	20	84
SNV270	71.5	20	96.5
SNV280	68	20	92.5
SNV290	76	20	102.5
SNV300	73	20	99.5
SNV320	77	20	104.5
SNV340	81	20	109.5

Lubrication

Automatic lubricators

It is also possible to screw automatic FAG lubricators, Motion Guard Compact or Motion Guard Champion, directly into the SNV housings. They constantly supply a sufficient amount of fresh grease to the contact areas of the rolling bearings. The bearing service life is far longer as a result. The reliable and cost-effective devices extend lubrication and maintenance intervals and eliminate the risk of supplying too little or too much grease. The plant downtimes are shorter and maintenance costs less. The use of economical and environmentally friendly lubricants contributes towards greater operational efficiency.

The FAG lubricators, Motion Guard COMPACT and Motion Guard CHAMPION, are individually adjusted to the bearing location and make costly central lubrication plants superfluous. They can be used everywhere: pumps, compressors and fans, conveyor plants, vehicles etc. Six Arcanol greases can be discharged with Motion Guard COMPACT, whereas all of the fourteen Arcanol greases can be discharged with Motion Guard CHAMPION (see table on page 9).

The order designations for the lubricators are specified in the LUB Technical Specification, see page 9. The 1st recognition letter identifies the grease type. The 2nd recognition letter in the CHAMPION designation identifies the LC-unit (A or B for 120 or 250 cm³, respectively), the 2nd recognition letter in the COMPACT designation identifies the activation screw (C, D, E or F for 1, 3, 6 or 12 months).

Advantages

- Individual and precise supply to each bearing location immediately after setting into operation
- Fully automatic, maintenance-free operation
- Cuts staff costs in comparison to manual relubrication
- 4 adjustable discharge periods (1, 3, 6 or 12 months)
- No danger of mixing up lubricants

- Builds up pressure to 4 bar (CHAMPION 5 bar), thus overcoming any hindrance
- Extensive accessory programme

Each lubricator is delivered with detailed operating instructions.

The MOTION GUARD SELECT MANAGER software makes it easier to select a suitable design and suitable lubricating greases (see also Publ. No. WL 81 116 for Arcanol greases). For more detailed information on FAG lubricators, see also FAG Publ. No. WL 81 122.



LUB Technical Specification for Motion Guard CHAMPION and COMPACT

1st recognition letter	Grease type	Grease suitable for CHAMPION	COMPACT
A	MULTITOP	+	-
B	MULTI2	+	-
C	MULTI3	+	-
D	LOAD220	+	-
E	LOAD400	+	+
F	LOAD1000	+	+
G	TEMP90	+	+
H	TEMP110	+	-
I	TEMP120	+	+
J	TEMP200	+	+
K	SPEED2.6	+	-
L	VIB3	+	-
M	BIO2	+	-
N	FOOD2	+	+

2nd recognition letter

LC-unit (lubricant canister) filled with 120 or 250 cm³ for CHAMPION

Activation screw for 1, 3, 6 or 12 months for COMPACT

A	ARCA.LUB.Fett.LC120.SET	
B	ARCA.LUB.Fett.LC250.SET	
C		ARCA.LUB.Fett.1M
D		ARCA.LUB.Fett.3M
E		ARCA.LUB.Fett.6M
F		ARCA.LUB.Fett.12M

„Fett“ means one of the suitable greases (see 1st recognition letter).

Ordering examples for lubricators

SNV100.LUB.EA

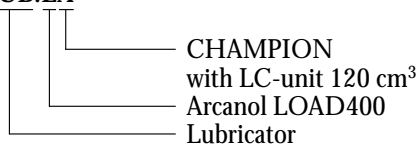

SNV100.LUB.JE

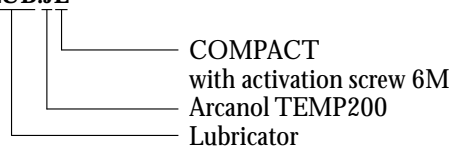

Lubrication

Grease valves

For high-speed operation, e.g. with fan bearing arrangements, FAG supply RSV grease valves upon request, fig. 7.

Grease valves for SNV housings of design G944A* must be listed separately in the order. RSV5 or RSV6 grease valves are used for bearings with adapter sleeves while RSV2 or RSV3 valves are used for bearings with cylindrical bore.

7: RSV grease valve

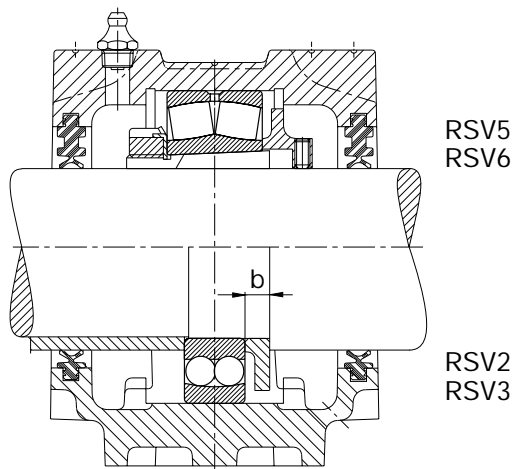

Grease valve	Width b	Grease valve	Width b
FAG	mm	FAG	mm
RSV205 to 211	8	RSV305 to 308	8
RSV212 to 218	10	RSV309 to 313	10
RSV219 to 222	13	RSV314 to 316	13
RSV224 to 232	15	RSV317 to 322	15
		RSV324 to 332	16

Oil lubrication

The SNV housings are designed for both oil sump and circulation oil lubrication. The housings are spacious with oil collecting pockets in the base, oil inlet and outlet holes, holes for connecting oil level gauges and temperature sensors. Connection dimensions fig. 8.

In the case of oil sump lubrication a minimum oil level must be maintained (h3 dimension in fig. 8). If FAG two-lip seals are used, a certain leakage must be taken into account. Leakage is inevitable with split seals and with seals which are not spring-preloaded. To keep the leakage rate down, the seal contact surface on the shaft should have the following quality:

hardness at least 55 HRC,

ground twist-free with $R_a = 0.2 \mu\text{m}$ to max. $0.5 \mu\text{m}$.

The joint between housing top and base must be sealed with a thin layer of a commercial sealing compound (permanent elasticity). In the case of housings closed at one end, the groove bottom must also be filled with the sealing compound.

Technically-speaking, an oil-proof design is only possible with a spring-preloaded, unsplit radial shaft seal. Please note: the housing must be ventilated in the case of oil sump lubrication (e.g. closing the inlet hole with a ventilation plug). Please contact the FAG advisory service about design and availability.

8: Dimensions recommended for the connecting holes of oil inlet, oil outlet and and oil-sight glass for oil sump lubrication.
For oil circulation lubrication the bore M4 can be used as the oil outlet.

SNV housings for oil sump lubrication (suffix G944BA) contain
 1 Oil-sight glass OSLG.MOD24OMR-R../...,
 1 Vent VENT.MOD556E-R../...,
 2 Plugs VSB.DIN906-M10x1-ST.
 FAG supply the G944BA design upon request.

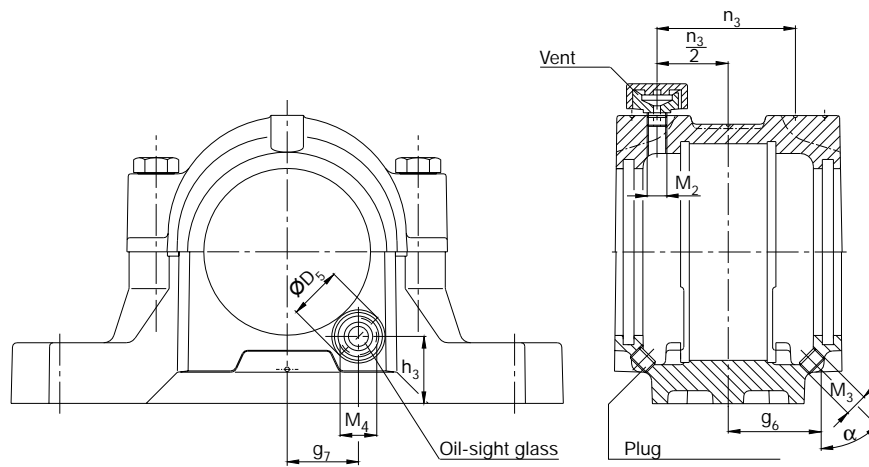

Housing	Connection for oil inlet		Connection for oil outlet			Connection for oil-sight glass			
	M ₂	$\frac{n_3}{2}$ mm	M ₃	α °	g ₆ mm	M ₄	g ₇ mm	h ₃	D ₅
SNV100	G ^{1/4}	31	M10x1	50	44	G ^{3/8}	33	31	25
SNV110	G ^{1/4}	33.5	M10x1	50	46	G ^{3/8}	35	28	25
SNV120	G ^{1/4}	35.5	M10x1	50	49	G ^{3/8}	38	35	25
SNV125	G ^{1/4}	28.5	M10x1	50	49	G ^{3/8}	44	24	25
SNV130	G ^{1/4}	38	M10x1	50	51.5	G ^{1/2}	43	28.5	30
SNV140	G ^{1/4}	40.5	M10x1	60	57.5	G ^{1/2}	45	40	30
SNV150	G ^{1/4}	42.5	M10x1	60	60	G ^{1/2}	47	38	30
SNV160	G ^{1/4}	45	M10x1	60	62.5	G ^{1/2}	50	39	30
SNV170	G ^{1/4}	46.5	M10x1	60	64	G ^{3/4}	55	46	38
SNV180	G ^{1/4}	49.5	M10x1	60	69	G ^{3/4}	57	43	38
SNV190	G ^{1/4}	49.5	M10x1	60	68.5	G ^{3/4}	48	45	38
SNV200	G ^{1/4}	55.5	M10x1	60	77.5	G ^{3/4}	62	50	38
SNV215	G ^{1/4}	58.5	M10x1	60	80	G ^{3/4}	67	58	38
SNV230	G ^{1/4}	61	M10x1	60	83	G ^{3/4}	70	60	38
SNV240	G ^{1/4}	60	M10x1	60	81.5	G ^{3/4}	61	60	38
SNV250	G ^{1/4}	65.5	M10x1	60	89	G ^{3/4}	75	55	38
SNV260	G ^{1/4}	62.5	M10x1	60	84	G ^{3/4}	65	65	38
SNV270	G ^{1/4}	71.5	M10x1	60	96.5	G ^{3/4}	81	55	38
SNV280	G ^{1/4}	68	M10x1	60	92.5	G ^{3/4}	70	60	38
SNV290	G ^{1/4}	76	M10x1	60	102.5	G ^{3/4}	87	58	38
SNV300	G ^{1/4}	73	M10x1	60	99.5	G ^{3/4}	75	70	38
SNV320	G ^{1/4}	77	M10x1	60	104.5	G ^{3/4}	80	73	38
SNV340	G ^{1/4}	81	M10x1	60	109.5	G ^{3/4}	95	75	38

Mounting

Mounting Instructions

Correct mounting has a decisive influence on the attainable life of the bearing.

Careful attention should therefore be paid to the following mounting instructions. Further information can be found in the FAG Publ. No. WL 80 100 „Mounting and Dismounting Rolling Bearings“.

The bearings which fit into the SNV housings can be fastened onto the shaft with adapter sleeves or seated directly on the shaft with a cylindrical bore. The required machining tolerances of the shaft can be taken from the catalogue WL 41 520 „FAG Rolling Bearings“. When using adapter sleeves, the tight fit is obtained by pushing the inner ring axially onto the shaft and from the resulting radial expansion of the inner ring. The axial displacement or reduction in radial clearance of the bearing is the dimension (see table 9 for recommended values). Pressing on is facilitated by using

an FAG hydraulic nut.

In the case of spherical roller bearings the reduction in radial clearance is determined by measuring the remaining clearance with feeler gauges. Self-aligning ball bearings are pressed so far onto the sleeve until a slight resistance can be felt when the outer ring is swivelled out. However, the outer ring must be easy to rotate in circumferential direction.

Housing tops and bases are not interchangeable.

The support surface must first be cleaned and checked for flatness prior to mounting the SNV plummer block housings.

See section „Loadability“, page 16, for flatness tolerances (DIN ISO 1101).

The housing base, which has been cleaned, is then fixed to the support surface with the fastening bolts. The bolts should not be fully tightened so that the housing can be adjusted at a later stage.

After adjusting the housing, the fastening bolts must be tightened as required.

Mounting the bearings on the shaft

Bearings with a cylindrical bore are pressed onto the shaft or, even better, pushed on in heated condition. The bearing inner ring must abut the shaft shoulder accurately. If necessary, press again after cooling.

When mounting bearings with tapered bores and adapter sleeves it must be insured that the bearing is seated in the centre of the housing before fixing. This is achieved by inserting the shaft with the bearing in the housing base and adjusting it. Axial displacement of the bearing on the sleeve must also be taken into consideration.

Mounting split spherical roller bearings

Split FAG spherical roller bearings are mounted similarly. Particularities for mounting split bearings are enclosed with the bearings upon delivery.

9: Reduction in radial clearance for FAG spherical roller bearings with tapered bore

Nominal bore		Radial clearance prior to mounting Clearance group						Reduction in radial clearance ¹⁾				Axial displacement on the taper 1:12 ¹⁾				Control value for the radial clearance after mounting		
d	to	CN (normal)		C3		C4				Shaft		Sleeve		CN	C3	C4		
over mm	mm	min	max	min	max	min	max	min	max	min	max	min	max	min	min	min		
24	30	0.03	0.04	0.04	0.055	0.055	0.075	0.015	0.02	0.3	0.35	0.3	0.4	0.015	0.02	0.035		
30	40	0.035	0.05	0.05	0.065	0.065	0.085	0.02	0.025	0.35	0.4	0.35	0.45	0.015	0.025	0.04		
40	50	0.045	0.06	0.06	0.08	0.08	0.1	0.025	0.03	0.4	0.45	0.45	0.5	0.02	0.03	0.05		
50	65	0.055	0.075	0.075	0.095	0.095	0.12	0.03	0.04	0.45	0.6	0.5	0.7	0.025	0.035	0.055		
65	80	0.07	0.095	0.095	0.12	0.12	0.15	0.04	0.05	0.6	0.75	0.7	0.85	0.025	0.04	0.07		
80	100	0.08	0.11	0.11	0.14	0.14	0.18	0.045	0.06	0.7	0.9	0.75	1	0.035	0.05	0.08		
100	120	0.1	0.135	0.135	0.17	0.17	0.22	0.05	0.07	0.7	1.1	0.8	1.2	0.05	0.065	0.1		
120	140	0.12	0.16	0.16	0.2	0.2	0.26	0.065	0.09	1.1	1.4	1.2	1.5	0.055	0.08	0.11		
140	160	0.13	0.18	0.18	0.23	0.23	0.3	0.075	0.1	1.2	1.6	1.3	1.7	0.055	0.09	0.13		

¹⁾ Only applicable to solid shafts made of steel and to hollow shafts with a bore not larger than half the shaft diameter.

The following applies: Bearings, whose radial clearance lies in the upper half of the tolerance range prior to mounting, are mounted with the higher value of the radial clearance reduction or axial displacement. Bearings in the lower half of the tolerance range with the lower value of the radial clearance reduction or axial displacement.

Mounting sequence for SNV housings with the two-lip seal DH (fig. 10)

1. Clean and check support surface.
2. Lock housing base into position.
3. Mount bearing on shaft and fill its cavities with some of the grease quantity according to table 5.
4. Fill space between the sealing lips with grease. Place each of the sealing halves in the grooves of the housing base.
5. Insert shaft with bearing in housing base. Insert both locating rings for locating bearing. The floating bearing should be positioned in the housing centre. In the case of housings closed at one end insert only one seal and, at the opposite side, the cover DKV into the housing grooves.
6. Align housing base and tighten fastening bolts in housing foot with recommended tightening torque, table 13.
7. Distribute equally the remaining bearing grease (point 3) between housing top and base.
8. Insert greased seal halves into the grooves of housing top.
9. Mount housing top and tighten fastening bolts with recommended tightening torque, table 13.

10: Mounting of SNV housings with two-lip seals DH

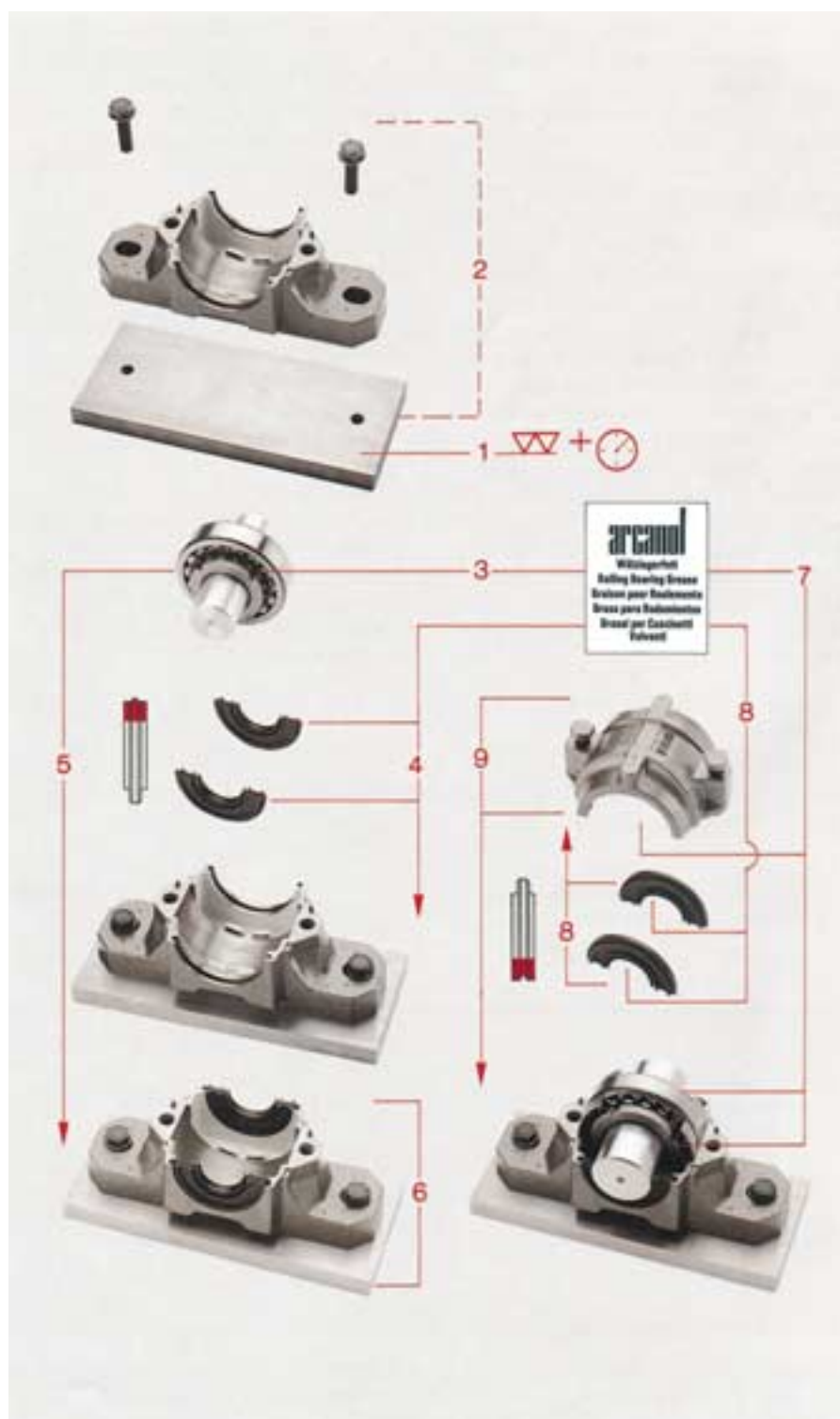

Mounting sequence for SNV housings with the labyrinth seal TSV (fig. 12)

1. Clean and check support surface.
2. Lock housing base into position.
3. Push one labyrinth ring onto shaft. The groove in the bore of the ring must be on the outside.
4. Mount bearing on shaft and fill its cavities with some of the grease quantity according to table 5.
5. If necessary, push the second labyrinth ring onto shaft (note position). For bearings closed at one end place the cover DKV into the housing groove.
6. Grease labyrinth
7. Insert shaft with mounted bearing and labyrinth rings in housing base. Insert both locating rings for locating bearing. The floating bearing should be positioned in the housing centre.
8. Align housing base and tighten fastening bolts in housing foot with the recommended tightening torque, table 13.
9. The bores of the labyrinth rings have an annular groove. An O ring is forced into the groove by simultaneously turning the shaft with a screwdriver. Then adjust the distance between the labyrinth rings and the housing grooves so that equal axial gaps are obtained.
10. Distribute equally the remaining bearing grease (point 4) between the housing top and base.
11. Mount housing top and tighten fastening bolts with the recommended tightening torque, table 13.

12: Mounting of SNV housings with labyrinth seals TSV

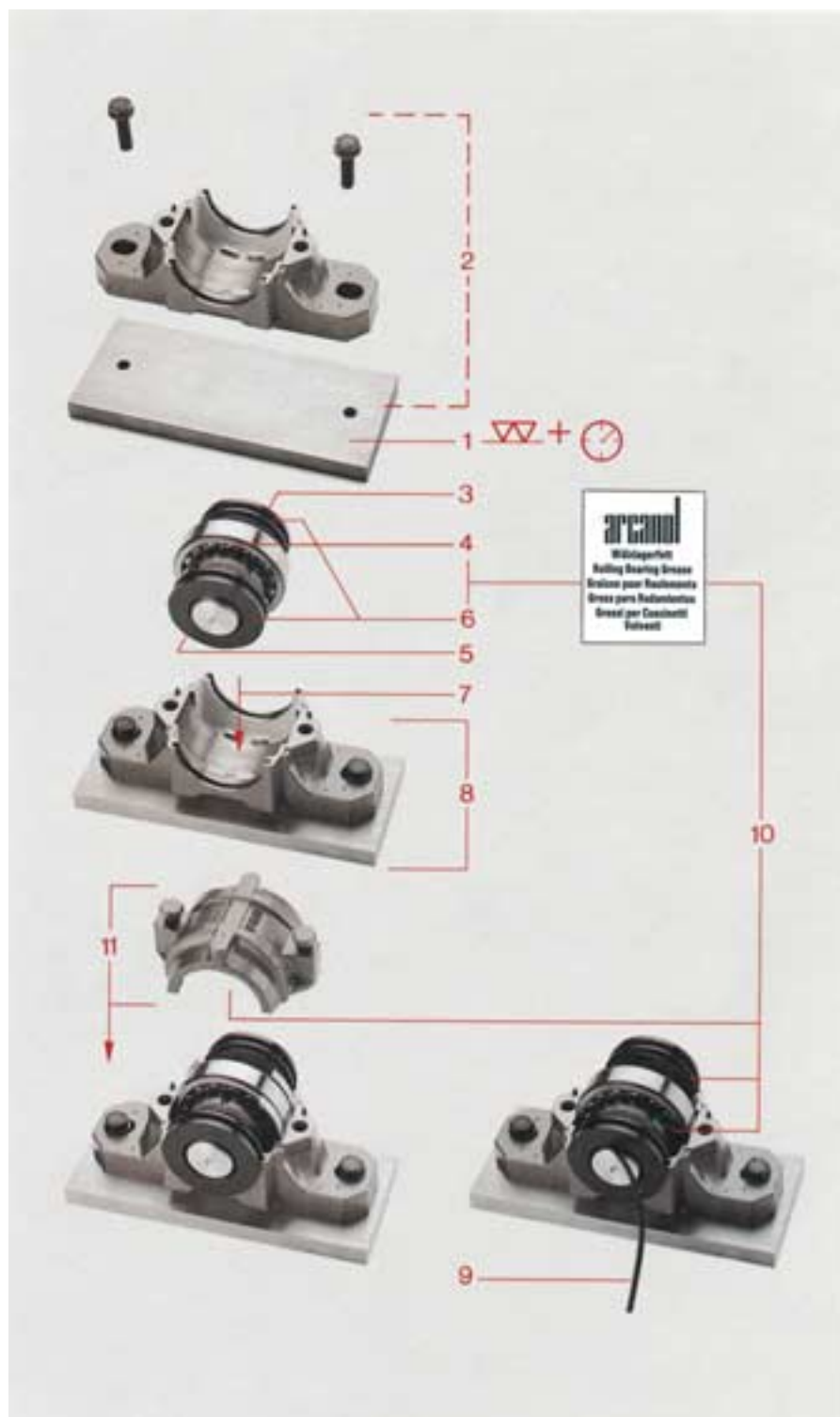

Additional holes for fastening bolts and pins · Loadability

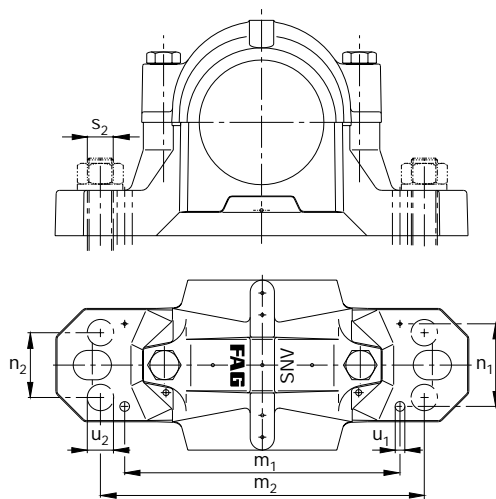

Additional holes for fastening bolts and pins

SNV housings are normally fastened with two bolts. The housing base has two slots which allow the housings to be aligned during mounting (dimensions m , u , v from page 20 on).

Four bolts are required for fastening on T section supports. Spots (dimensions m_2 and n_2) are marked where additional holes (diameter u_2) can be drilled for fastening bolts (s_2). FAG supply upon request housings from size SNV080 on with these four additional holes for fastening bolts. The order should then be, for example: FAG plummer block housing SNV080.G944DA.

Holes (diameter u_1) can be drilled at the marked spots (dimensions m_1 , n_1) for pins to secure the bearing positions.

Housing Codes	Dimensions for pins			Dimensions for bolts			
	m_1	n_1	u_1	m_2	n_2	u_2	s_2
FAG	mm			mm			inch
SNV052	95	32	4	115	25		
SNV062	115	36	4	130	25		
SNV072	115	37	4	135	25		
SNV080	135	43	4	160	34	11	M10 3/8
SNV085	135	40	4	160	34	11	M10 3/8
SNV090	135	44	6	160	34	11	M10 3/8
SNV100	170	51	6	200	40	14	M12 1/2
SNV110	170	52	6	200	40	14	M12 1/2
SNV120	190	58	6	220	48	14	M12 1/2
SNV125	190	52	4	220	48	14	M12 1/2
SNV130	190	60	8	220	48	14	M12 1/2
SNV140	210	65	8	252	52	18	M16 5/8
SNV150	210	66	8	252	52	18	M16 5/8
SNV160	240	72	8	280	58	18	M16 5/8
SNV170	240	74	8	280	58	18	M16 5/8
SNV180	261	80	8	300	66	18	M16 5/8
SNV190	271	81	8	300	66	18	M16 5/8
SNV200	291	88	8	320	74	18	M16 5/8
SNV215	297	91	8	330	74	18	M16 5/8
SNV230	325	97	10	370	80	22	M20 3/4
SNV240	328	96	10	370	80	22	M20 3/4
SNV250	342	109	12	400	92	26	M24 7/8
SNV260	372	113	12	430	100	26	M24 7/8
SNV270	372	116	12	430	100	26	M24 7/8
SNV280	392	114	12	450	100	26	M24 7/8
SNV290	392	120	12	450	100	26	M24 7/8
SNV300	442	123	12	500	100	26	M24 7/8
SNV320	482	130	12	540	100	26	M24 7/8
SNV340	489	138	14	570	100	33	M30 1 1/4

Loadability

The breaking loads of the SNV housings based on the load direction are indicated in table 13, page 17.

These values apply if the support surfaces of the mating parts are finished with a flatness tolerance of IT8 according to DIN ISO 1101 (related to distance a). An overall and rigid support of the housing base is a precondition for the accommodation of the loads. The common safety factors which apply in general in mechanical engineering must be taken into consideration when determining the values for the permissible load (see page 18).

13: Standard values for the breaking load of SNV housings and the maximum loadability of connecting bolts

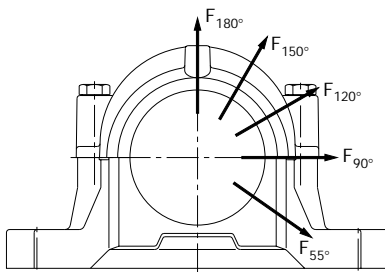

For compensation of the housing breaking load value a safety factor of 6 is recommended.

Housing Code	Housing breaking load in load direction					Connecting bolts			Holding-down bolts*)			
	55°	90°	120°	150°	180°	Thread according to DIN 13	Maximum loadability of both bolts with contact of joint surfaces in load direction			Thread according to DIN 13	Tightening torque**)	
FAG	kN					Material 8.8	120°	150°	180°	Mat. 8.8	Mat. 8.8	Mat. 8.8
							kN			N m		
SNV052	160	95	70	60	80	M10	60	35	30	50	M12	85
SNV062	170	100	80	65	85	M10	60	35	30	50	M12	85
SNV072	190	110	85	80	95	M10	60	35	30	50	M12	85
SNV080	210	130	95	85	105	M10	60	35	30	50	M12	85
SNV085	225	140	100	90	120	M10	60	35	30	50	M12	85
SNV090	265	160	120	105	130	M10	60	35	30	50	M12	85
SNV100	280	170	125	120	140	M12	80	45	40	85	M16	210
SNV110	300	180	130	125	150	M12	80	45	40	85	M16	210
SNV120	335	200	150	130	170	M12	80	45	40	85	M16	210
SNV125	335	200	150	130	170	M12	80	45	40	85	M16	210
SNV130	400	250	180	150	200	M12	80	45	40	85	M16	210
SNV140	425	265	190	170	210	M12	80	45	40	85	M20	410
SNV150	475	280	200	180	235	M12	80	45	40	85	M20	410
SNV160	530	335	250	210	265	M16	180	100	90	210	M20	410
SNV170	560	355	265	225	280	M16	180	100	90	210	M20	410
SNV180	630	375	280	250	300	M20	260	150	130	410	M24	710
SNV190	630	375	280	250	300	M20	260	150	130	410	M24	710
SNV200	670	400	315	280	335	M20	260	150	130	410	M24	710
SNV215	800	450	355	315	400	M20	260	150	130	410	M24	710
SNV230	900	530	400	355	450	M24	360	210	180	710	M24	710
SNV240	1000	600	450	400	500	M24	360	210	180	710	M24	710
SNV250	1060	630	475	425	530	M24	360	210	180	710	M30	1450
SNV260	1180	710	530	475	600	M24	360	210	180	710	M30	1450
SNV270	1180	710	530	475	600	M24	360	210	180	710	M30	1450
SNV280	1320	750	600	530	630	M24	360	210	180	710	M30	1450
SNV290	1400	850	630	560	710	M24	360	210	180	710	M30	1450
SNV300	1500	900	670	600	750	M24	360	210	180	710	M30	1450
SNV320	1700	1000	750	670	850	M24	360	210	180	710	M30	1450
SNV340	1900	1120	850	750	950	M30	640	370	320	1450	M36	2600

*) Holding-down bolts are not supplied by FAG.

**) The tightening torques are maximum values at a 90% utilization of the yield strength of the bolt material and a coefficient of friction of 0.14. We recommend tightening the bolts to 70% of these values.

Loadability · Codes · How to Order

The safety factors are:

- 6 for the breaking load of the housing
- 3 for the maximum loadability of connecting bolts and holding-down bolts.

The maximum axial housing load is assumed to be two thirds of the breaking load value F_{180° . In this case the permissible axial loadability of the bearings used and the axial holding force of bearings on sleeves without positive contact must be considered (see FAG TI No. WL 80-14). For load directions between 55° and 120° or for axial load the housing must be secured at the foot with stops in the load direction if the force acting parallel to the clamping surface exceeds $0.05 \cdot F_{180^\circ}$.

The maximum permissible load on eyebolts in the housing top is the weight of the housing together with the bearing.

Codes

The housing code is made up of the designation of the housing series SNV and the bearing outside diameter in mm, e.g. SNV100.

Bearings and adapter sleeves, locating rings, seals and covers must be ordered separately (see following examples of how to order). The accessories required for the housing based on the bearing provided are indicated in the dimension tables.

Examples of how to order

EXAMPLE 1

Plummer block housing, closed on one side, self-aligning ball bearing 2210K.TV.C3 as a locating bearing, adapter sleeve, two-lip seal.

Order:
1 plummer block housing FAG SNV090
1 self-aligning ball bearing FAG 2210K.TV.C3
1 adapter sleeve FAG H310
2 locating rings FAG FRM90/9
1 cover FAG DKV090
1 two-lip seal FAG DH510

EXAMPLE 2

Plummer block housing for through shaft, spherical roller bearing 22212E1K as a floating bearing, adapter sleeve, two-lip seals.

Order:
1 plummer block housing FAG SNV110
1 spherical roller bearing FAG 22212E1K
1 adapter sleeve FAG H312
2 two-lip seals FAG DH512

EXAMPLE 3

Plummer block housing for through shaft, split spherical roller bearing 222SM70T as a locating bearing, two-lip seal.

Order:
1 plummer block housing FAG SNV140
1 split spherical roller bearing FAG 222SM70T
2 locating rings FAG FRM140/12,5
2 two-lip seals FAG DH516

EXAMPLE 4

Plummer block housing with labyrinth seal, one end closed, spherical roller bearing 22216E1K as a floating bearing, adapter sleeve.

Order:
1 plummer block housing FAG SNV140
1 spherical roller bearing FAG 22216E1K
1 adapter sleeve FAG H316
1 labyrinth ring FAG TSV516
1 cover FAG DKV140

EXAMPLE 5

Plummer block housing, one end closed, spherical roller bearing 23218E1TVPB as a floating bearing, felt seal.

Order:
1 plummer block housing FAG SNV160
1 spherical roller bearing FAG 23218E1TVPB
1 shaft nut FAG KM18
1 lock washer FAG MB18A
1 cover FAG DKV160
1 felt seal FAGFSV218

FAG plummer block housings, split

for bearings with cylindrical bore and
for bearings with tapered bore and adapter sleeve

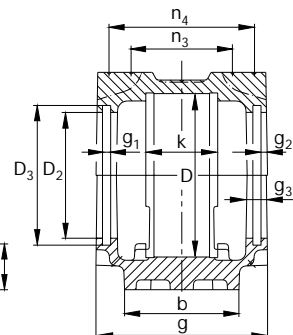
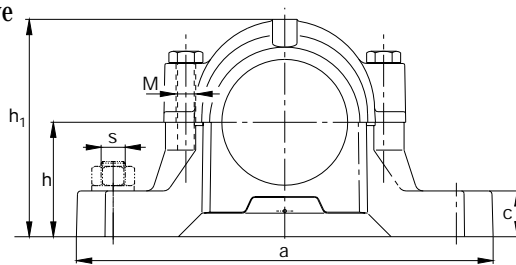
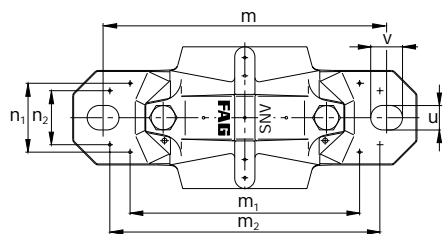

SNV052

Dimensions

D	a	b	c	g	h	m	s	u	v	h ₁	D ₂	D ₃	D ₅	
mm							mm	inch	mm					
52	165	46	19	70	40	130	M12	1/2	15	20	75	36.5	44.5	42.7

Shaft

d ₁	d	d ₂	Bearings which fit the housing				Split spherical roller bearing	
mm	inch	mm	Codes according to DIN*				FAG	
19.05	3/4		1205K	20205K		2205K	22205K	
20		25	6304	1304	20304	21304	2205K	22205K
		25				2304		
20.638	13/16		1205K	20205K		2205K	22205K	
25		30	6205	1205	20205	2205	22205	
		30						

* The order designation in the code according to DIN can be taken from the catalogue WL 41520EA „FAG Rolling Bearings“

Bearing with tapered bore and adapter sleeve

Bearing with cylindrical bore

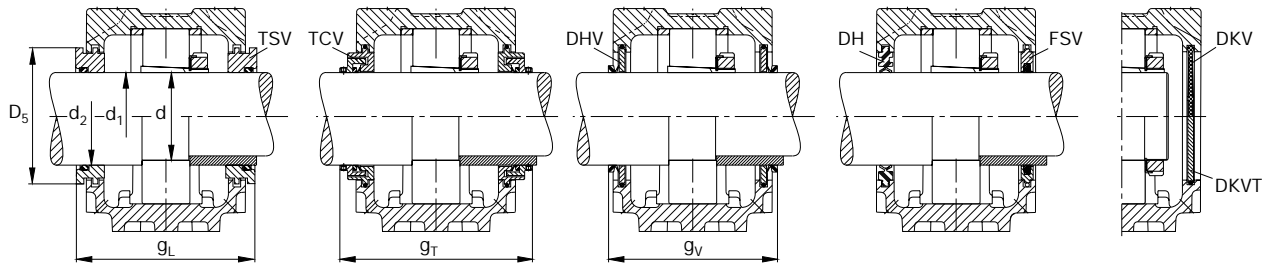

g_1	g_2	g_3	g_L	g_T	g_V	k	m_1	n_1	m_2	n_2	n_3	n_4	M DIN 931	M ₁ DIN 580	Mass ≈ kg
5	3	10.5	83 ¹⁾	-	76	27	95	32	115	25	38	56	M10	-	1.3

Required accessories

Adapter sleeve	Locknut	Lock washer	Locating ring 2 pieces	Two-lip seal	V-ring seal	Labyrinth ring with O ring	Felt seal	Combined seal	Cover**
FAG	FAG	FAG	FAG	FAG	FAG	FAG	FAG	FAG	FAG
H205.012 H305.012			FRM52/6 FRM52/4,5	DH505.012 DH505.012	DHV505.012 DHV505.012	TSV505.012 TSV505.012	FSV505.012 FSV505.012		DKV052 DKV052
H205 H305	KM4 KM4	MB4 MB4	FRM52/6 FRM52/4.5 FRM52/6 FRM52/3	DH505 DH505 DH304 DH304	DHV505 DHV505 DHV304 DHV304	TSV505 TSV505 TSV304 TSV304	FSV505 FSV505 FSV304 FSV304		DKV052 DKV052 DKV052 DKV052
H205.013 H305.013			FRM52/6 FRM52/4.5	DH505 DH505	DHV505 DHV505	TSV505.013 TSV505.013	FSV505 FSV505		DKV052 DKV052
	KM5 KM5	MB5 MB5	FRM52/6 FRM52/4.5	DH205 DH205		TSV205 TSV205			DKV052 DKV052

¹⁾ 95 mm at TSV205 and TSV304

** for temperatures > 120 °C we recommend covers DKVT...

FAG plummer block housings, split

for bearings with cylindrical bore and
for bearings with tapered bore and adapter sleeve

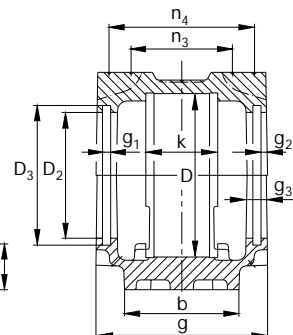
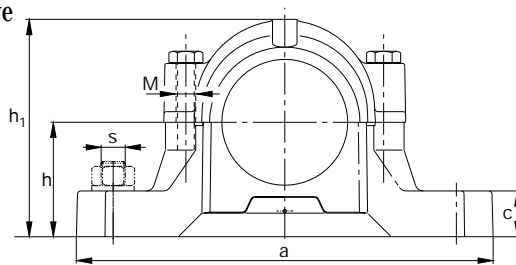
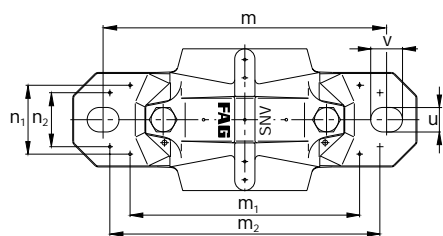

SNV062

Dimensions

D	a	b	c	g	h	m	s	u	v	h ₁	D ₂	D ₃	D ₅	
mm							mm	inch	mm					
62	185	52	22	75	50	150	M12	1/2	15	20	91	41.5	49.5	47.7

Shaft

d ₁ d		d ₂	Bearings which fit the housing Unsplit bearings				Split spherical roller bearing	
mm	inch	mm	Codes according to DIN*				FAG	
19.05	3/4		1305K	20305K			2305K	
20			1305K	20305K			2305K	
22.225	7/8		1206K	20206K			2206K	22206K
23.813	15/16		1206K	20206K			2206K	22206K
25		30	6305	1305	20305	21305	2206K	22206K
		30					2305	
25.4	1		1206K	20206K			2206K	22206K
30		35	6206	1206	20206		2206	22206
		35						

* The order designation in the code according to DIN can be taken from the catalogue WL 41520EA „FAG Rolling Bearings“

Bearing with tapered bore and adapter sleeve

Bearing with cylindrical bore

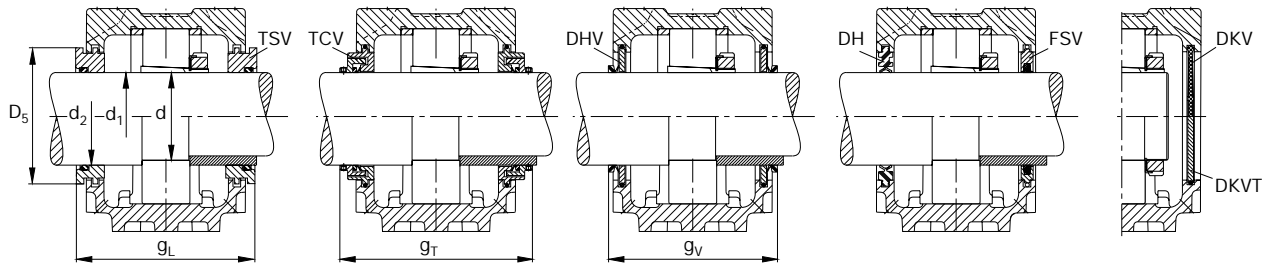

g_1	g_2	g_3	g_L	g_T	g_V	k	m_1	n_1	m_2	n_2	n_3	n_4	M DIN 931	M ₁ DIN 580	Mass ≈ kg
5	3	10.5	88 ¹⁾	-	76	30	115	36	130	25	42	61	M10	-	1.9

Required accessories

Adapter sleeve FAG	Locknut FAG	Lock washer FAG	Locating ring 2 pieces FAG	Two-lip seal FAG	V-ring seal FAG	Labyrinth ring with O ring FAG	Felt seal FAG	Combined seal FAG	Cover** FAG
H305.012 H2305.012			FRM62/6.5 FRM62/3	DH605.012 DH605.012	DHV605.012 DHV605.012	TSV605.012 TSV605.012	FSV605.012 FSV605.012		DKV062 DKV062
H305 H2305			FRM62/6.5 FRM62/3	DH605 DH605	DHV605 DHV605	TSV605 TSV605	FSV605 FSV605		DKV062 DKV062
H206.014 H306.014			FRM62/7 FRM62/5	DH506.014 DH506.014	DHV506.014 DHV506.014	TSV506.014 TSV506.014	FSV506.014 FSV506.014		DKV062 DKV062
H206.015 H306.015			FRM62/7 FRM62/5	DH506.014 DH506.014	DHV506.015 DHV506.015	TSV506.015 TSV506.015	FSV506.015 FSV506.015		DKV062 DKV062
H206 H306	KM5 KM5	MB5 MB5	FRM62/7 FRM62/5 FRM62/6.5 FRM62/3	DH506 DH506 DH305 DH305	DHV506 DHV506 DHV305 DHV305	TSV506 TSV506 TSV305 TSV305	FSV506 FSV506 FSV305 FSV305		DKV062 DKV062 DKV062 DKV062
H206.100 H306.100			FRM62/7 FRM62/5	DH506 DH506	DHV506 DHV506	TSV506.100 TSV506.100	FSV506 FSV506		DKV062 DKV062
	KM6 KM6	MB6 MB6	FRM62/7 FRM62/5	DH206 DH206		TSV206 TSV206			DKV062 DKV062

¹⁾ 100 mm at TSV206 and TSV305

** for temperatures > 120 °C we recommend covers DKVT...

FAG plummer block housings, split

for bearings with cylindrical bore and
for bearings with tapered bore and adapter sleeve

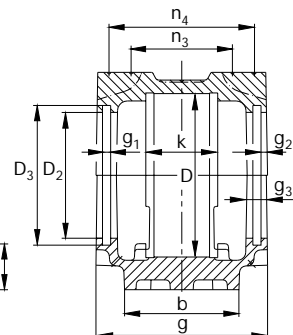
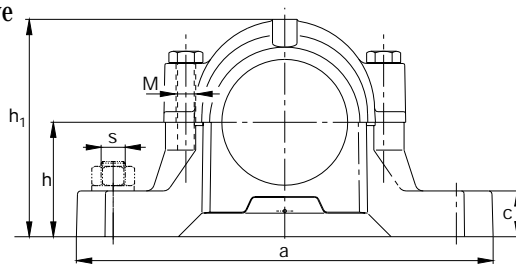
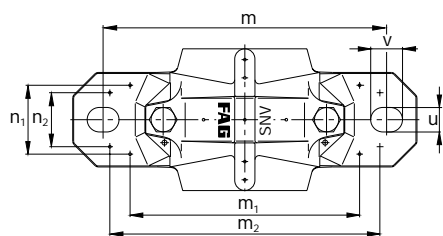

SNV072

Dimensions

D	a	b	c	g	h	m	s	u	v	h ₁	D ₂	D ₃	D ₅	
mm							mm	inch	mm					
72	185	52	22	80	50	150	M12	1/2	15	20	97	51.5	59.5	57.7

Shaft

d ₁ d		d ₂	Bearings which fit the housing				Split spherical roller bearing	
mm	inch	mm	Codes according to DIN*				FAG	
22.225	7/8		1306K	20306K			2306K	
23.813	15/16		1306K	20306K			2306K	
25			1306K	20306K			2306K	
25.4	1		1306K	20306K			2306K	
28.575	1 1/8		1207K	20207K			2207K	22207K
30			1207K	20207K			2207K	22207K
		35 35	6306	1306	20306	21306	2306	
30.163	1 3/16		1207K	20207K			2207K	22207K
35		45 45	6207	1207	20207		2207	22207

* The order designation in the code according to DIN can be taken from the catalogue WL 41520EA „FAG Rolling Bearings“

Bearing with tapered bore and adapter sleeve

Bearing with cylindrical bore

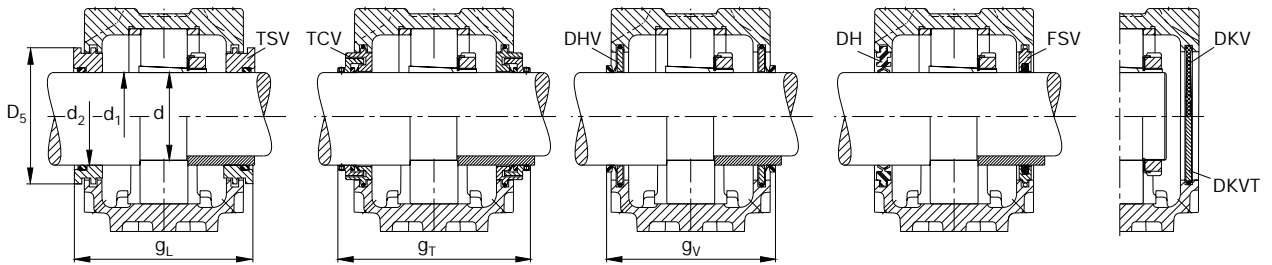

g_1	g_2	g_3	g_L	g_T	g_V	k	m_1	n_1	m_2	n_2	n_3	n_4	M DIN 931	M ₁ DIN 580	Mass ≈ kg
5	3	10.5	93 ¹⁾	117	86	33	115	37	135	25	46	66	M10	-	2

Required accessories

Adapter sleeve FAG	Locknut FAG	Lock washer FAG	Locating ring 2 pieces FAG	Two-lip seal FAG	V-ring seal FAG	Labyrinth ring with O ring FAG	Felt seal FAG	Combined seal FAG	Cover** FAG
H306.014 H2306.014			FRM72/7 FRM72/3	DH606.014 DH606.014	DHV606.014 DHV606.014	TSV606.014 TSV606.014	FSV606.014 FSV606.014	TCV606.014 TCV606.014	DKV072 DKV072
H306.015 H2306.015			FRM72/7 FRM72/3	DH606.014 DH606.014	DHV606.015 DHV606.015	TSV606.015 TSV606.015	FSV606.015 FSV606.015	TCV606.015 TCV606.015	DKV072 DKV072
H306 H2306			FRM72/7 FRM72/3	DH606 DH606	DHV606 DHV606	TSV606 TSV606	FSV606 FSV606	TCV606 TCV606	DKV072 DKV072
H306.100 H2306.100			FRM72/7 FRM72/3	DH606 DH606	DHV606 DHV606	TSV606.100 TSV606.100	FSV606 FSV606	TCV606 TCV606	DKV072 DKV072
H207.102 H307.102			FRM72/8 FRM72/5	DH507.102 DH507.102	DHV507.102 DHV507.102	TSV507.102 TSV507.102	FSV507.102 FSV507.102		DKV072 DKV072
H207 H307	KM6 KM6	MB6 MB6	FRM72/8 FRM72/5 FRM72/7 FRM72/3	DH507 DH507 DH306 DH306	DHV507 DHV507 DHV306 DHV306	TSV507 TSV507 TSV306 TSV306	FSV507 FSV507 FSV306 FSV306		DKV072 DKV072 DKV072 DKV072
H207.103 H307.103			FRM72/8 FRM72/5	DH507 DH507	DHV507 DHV507	TSV507 TSV507	FSV507 FSV507		DKV072 DKV072
	KM7 KM7	MB7 MB7	FRM72/8 FRM72/5	DH207 DH207		TSV207 TSV207			DKV072 DKV072

¹⁾ 107 mm at TSV207

** for temperatures > 120 °C we recommend covers DKVT...

FAG plummer block housings, split

for bearings with cylindrical bore and
for bearings with tapered bore and adapter sleeve

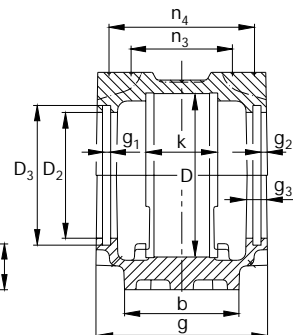
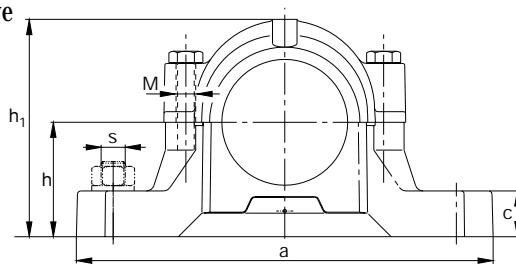
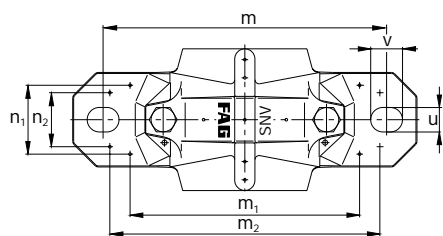

SNV080

Dimensions

D	a	b	c	g	h	m	s	u	v	h ₁	D ₂	D ₃	D ₅	
mm							mm	inch	mm					
80	205	60	25	85	60	170	M12	1/2	15	20	112	62	70.5	68.7

Shaft

d ₁	d	d ₂	Bearings which fit the housing				Split spherical roller bearing
mm	inch	mm	Codes according to DIN*				FAG

28.575	1 ¹ / ₈		1307K	20307K	21307K	2307K	
30			1307K	20307K	21307K	2307K	
30.163	1 ³ / ₁₆		1307K	20307K	21307K	2307K	
31.75	1 ¹ / ₄		1208K	20208K		2208K	22208K
33.338	1 ⁵ / ₁₆		1208K	20208K		2208K	22208K
34.925	1 ³ / ₈		1208K	20208K		2208K	22208K
35			1208K	20208K		2208K	22208K
		45	6307	1307	20307	21307	2307
40		50	6208	1208	20208		2208
		50					22208

* The order designation in the code according to DIN can be taken from the catalogue WL 41520EA „FAG Rolling Bearings“

Bearing with tapered bore and adapter sleeve

Bearing with cylindrical bore

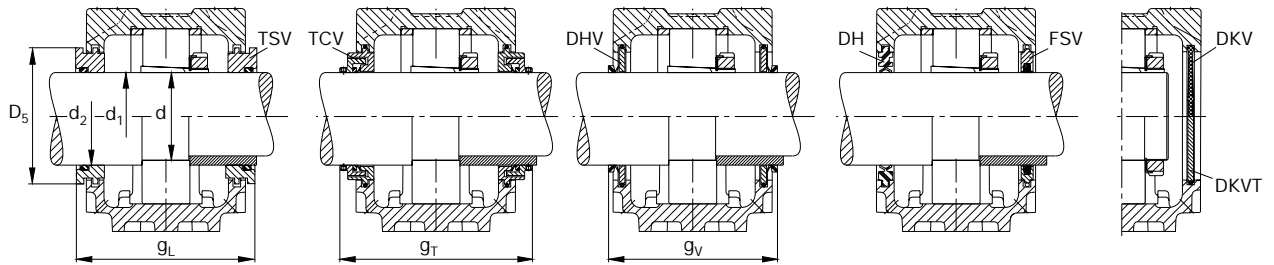

g_1	g_2	g_3	g_L	g_T	g_v	k	m_1	n_1	m_2	n_2	n_3	n_4	M DIN 931	M ₁ DIN 580	Mass ≈ kg
5	3	10.5	98	122	91 ¹⁾	39	135	43	160	34	52	71	M10	-	2.9

Required accessories

Adapter sleeve	Locknut	Lock washer	Locating ring 2 pieces	Two-lip seal	V-ring seal	Labyrinth ring with O ring	Felt seal	Combined seal	Cover**
FAG	FAG	FAG	FAG	FAG	FAG	FAG	FAG	FAG	FAG

H307.102 H2307.102			FRM80/9 FRM80/4	DH607.102 DH607.102	DHV607.102 DHV607.102	TSV607.102 TSV607.102	FSV607.102 FSV607.102	TCV607.102 TCV607.102	DKV080 DKV080
H307 H2307			FRM80/9 FRM80/4	DH607 DH607	DHV607 DHV607	TSV607 TSV607	FSV607 FSV607	TCV607 TCV607	DKV080 DKV080
H307.103 H2307.103			FRM80/9 FRM80/4	DH607 DH607	DHV607 DHV607	TSV607 TSV607	FSV607 FSV607	TCV607 TCV607	DKV080 DKV080
H208.104 H308.104			FRM80/10.5 FRM80/8	DH508.104 DH508.104	DHV508.104 DHV508.104	TSV508.104 TSV508.104	FSV508.104 FSV508.104	TCV508.104 TCV508.104	DKV080 DKV080
H208.105 H308.105			FRM80/10.5 FRM80/8	DH508.104 DH508.104	DHV508.105 DHV508.105	TSV508.105 TSV508.105	FSV508.105 FSV508.105	TCV508.105 TCV508.105	DKV080 DKV080
H208.106 H308.106			FRM80/10.5 FRM80/8	DH508 DH508	DHV508 DHV508	TSV508 TSV508	FSV508 FSV508	TCV508 TCV508	DKV080 DKV080
H208 H308	KM7 KM7	MB7 MB7	FRM80/10.5 FRM80/8 FRM80/9 FRM80/4	DH508 DH508 DH307 DH307	DHV508 DHV508 DHV307 DHV307	TSV508 TSV508 TSV307 TSV307	FSV508 FSV508 FSV307 FSV307	TCV508 TCV508	DKV080 DKV080 DKV080 DKV080
	KM8 KM8	MB8 MB8	FRM80/10.5 FRM80/8	DH208 DH208	DHV208 DHV208	TSV208 TSV208	FSV208 FSV208		DKV080 DKV080

¹⁾ 93 mm at DHV307 and DHV208

** for temperatures > 120 °C we recommend covers DKVT...

FAG plummer block housings, split

for bearings with cylindrical bore and
for bearings with tapered bore and adapter sleeve

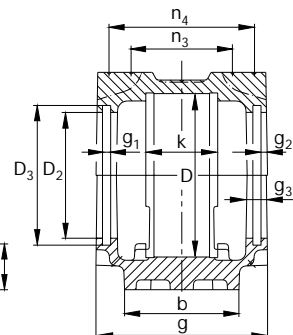
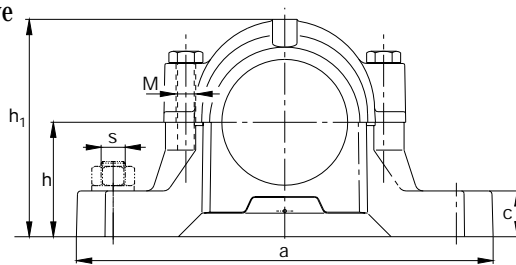
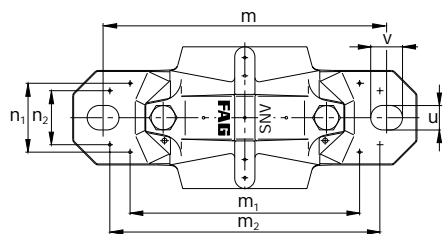

SNV085

Dimensions

D	a	b	c	g	h	m	s	u	v	h ₁	D ₂	D ₃	D ₅	
mm							mm	inch	mm					
85	205	60	25	87	60	170	M12	1/2	15	20	114	67	75.5	73.7

Shaft

d ₁	d	d ₂	Bearings which fit the housing				Split spherical roller bearing
mm	inch	mm	Codes according to DIN*				FAG
36.513	1 ⁷ / ₁₆		1209K	20209K		2209K	22209K
38.1	1 ¹ / ₂		1209K	20209K		2209K	22209K
40			1209K	20209K		2209K	22209K
45		55 55	6209	1209	20209	2209	22209

* The order designation in the code according to DIN can be taken from the catalogue WL 41520EA „FAG Rolling Bearings“

Bearing with tapered bore and adapter sleeve

Bearing with cylindrical bore

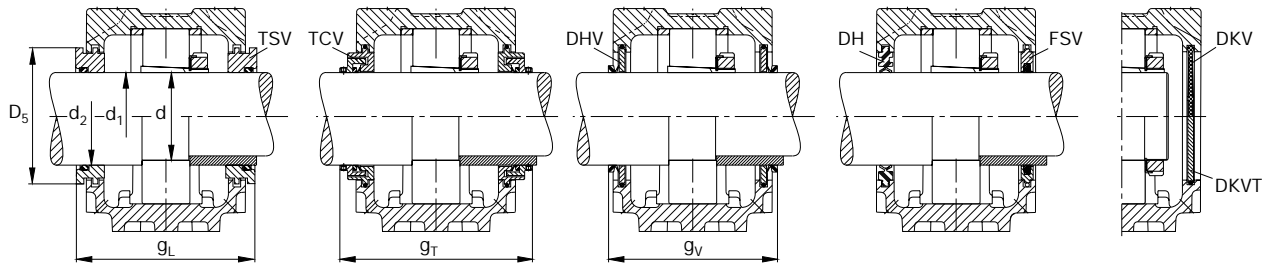

g_1	g_2	g_3	g_L	g_T	g_V	k	m_1	n_1	m_2	n_2	n_3	n_4	M DIN 931	M ₁ DIN 580	Mass ≈ kg
5	4	12.5	101	123 ¹⁾	91 ²⁾	31	135	40	160	34	47	71	M10	-	2.8

Required accessories

Adapter sleeve	Locknut	Lock washer	Locating ring 2 pieces	Two-lip seal	V-ring seal	Labyrinth ring with O ring	Felt seal	Combined seal	Cover**
FAG	FAG	FAG	FAG	FAG	FAG	FAG	FAG	FAG	FAG
H209.107 H309.107			FRM85/6 FRM85/4	DH509.107 DH509.107	DHV509.107 DHV509.107	TSV509.107 TSV509.107	FSV509.107 FSV509.107	TCV509.107 TCV509.107	DKV085 DKV085
H209.108 H309.108			FRM85/6 FRM85/4	DH509.107 DH509.107	DHV509.108 DHV509.108	TSV509.108 TSV509.108	FSV509.108 FSV509.108	TCV509.108 TCV509.108	DKV085 DKV085
H209 H309			FRM85/6 FRM85/4	DH509 DH509	DHV509 DHV509	TSV509 TSV509	FSV509 FSV509	TCV509 TCV509	DKV085 DKV085
	KM9 KM9	MB9 MB9	FRM85/6 FRM85/4	DH209 DH209	DHV209 DHV209	TSV209 TSV209	FSV209 FSV209		DKV085 DKV085

¹⁾ $g_T = 125$ mm at TCV509.108, TCV509

²⁾ $g_V = 93$ mm at DHV509.108, DHV509, DHV209

** for temperatures > 120 °C we recommend covers DKVT...

FAG plummer block housings, split

for bearings with cylindrical bore and
for bearings with tapered bore and adapter sleeve

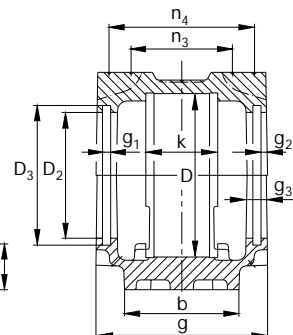
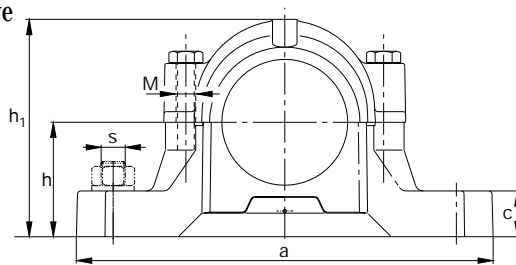
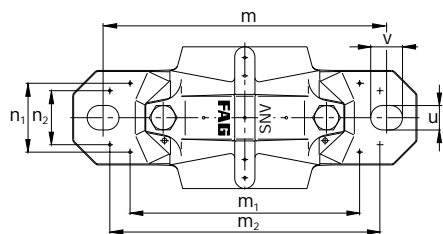

SNV090

Dimensions

D	a	b	c	g	h	m	s	u	v	h ₁	D ₂	D ₃	D ₅	
mm							mm	inch	mm					
90	205	60	25	100	60	170	M12	1/2	15	20	117	72	80.5	78.2

Shaft

d ₁ d		d ₂	Bearings which fit the housing						Split spherical roller bearing
mm	inch	mm	Codes according to DIN*						FAG
31.75	1 ¹ / ₄		1308K	20308K	21308K	2308K	22208K		
33.338	1 ⁵ / ₁₆		1308K	20308K	21308K	2308K	22308K		
34.925	1 ³ / ₈		1308K	20308K	21308K	2308K	22308K		
35			1308K	20308K	21308K	2308K	22308K		
40		50 50	6308	1308	20308	21308	2308	22308	
41.275	1 ⁵ / ₈		1210K	20210K		2210K	22210K		
42.863	1 ¹¹ / ₁₆		1210K	20210K		2210K	22210K		
44.45	1 ³ / ₄		1210K	20210K		2210K	22210K		
45			1210K	20210K		2210K	22210K		
50		60 60	6210	1210	20210	2210	22210		

* The order designation in the code according to DIN can be taken from the catalogue WL 41520EA „FAG Rolling Bearings“

Bearing with tapered bore and adapter sleeve

Bearing with cylindrical bore

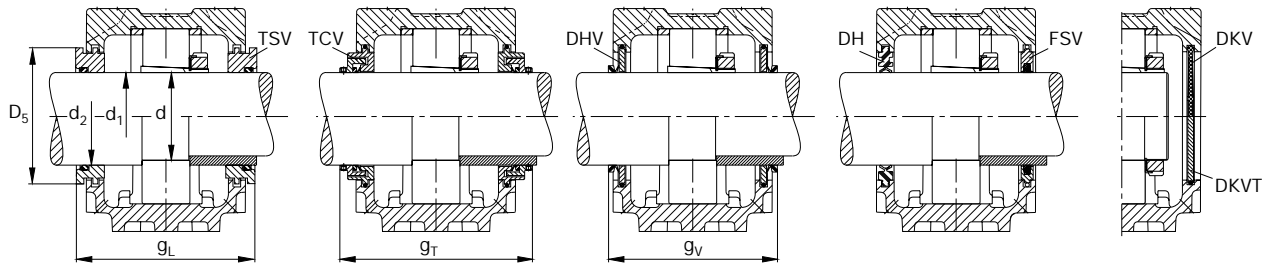

g_1	g_2	g_3	g_L	g_T	g_V	k	m_1	n_1	m_2	n_2	n_3	n_4	M DIN 931	M ₁ DIN 580	Mass ≈ kg
5	4	12.5	114	136 ¹⁾	104 ²⁾	41	135	44	160	34	58	84	M10	-	3.1

Required accessories

Adapter sleeve	Locknut	Lock washer	Locating ring 2 pieces	Two-lip seal	V-ring seal	Labyrinth ring with O ring	Felt seal	Combined seal	Cover**
FAG	FAG	FAG	FAG	FAG	FAG	FAG	FAG	FAG	FAG
H308.104 H2308.104			FRM90/9 FRM90/4	DH608.104 DH608.104	DHV608.104 DHV608.104	TSV608.104 TSV608.104	FSV608.104 FSV608.104	TCV608.104 TCV608.104	DKV090 DKV090
H308.105 H2308.105			FRM90/9 FRM90/4	DH608.104 DH608.104	DHV608.105 DHV608.105	TSV608.105 TSV608.105	FSV608.105 FSV608.105	TCV608.105 TCV608.105	DKV090 DKV090
H308.106 H2308.106			FRM90/9 FRM90/4	DH608 DH608	DHV608 DHV608	TSV608 TSV608	FSV608 FSV608	TCV608 TCV608	DKV090 DKV090
H308 H2308			FRM90/9 FRM90/4	DH608 DH608	DHV608 DHV608	TSV608 TSV608	FSV608 FSV608	TCV608 TCV608	DKV090 DKV090
	KM8 KM8	MB8 MB8	FRM90/9 FRM90/4	DH308 DH308	DHV308 DHV308	TSV308 TSV308	FSV308 FSV308		DKV090 DKV090
H210.110 H310.110			FRM90/10.5 FRM90/9	DH510.110 DH510.110	DHV510.110 DHV510.110	TSV510.110 TSV510.110	FSV510.110 FSV510.110	TCV510.110 TCV510.110	DKV090 DKV090
H210.111 H310.111			FRM90/10.5 FRM90/9	DH510.110 DH510.110	DHV510.111 DHV510.111	TSV510.111 TSV510.111	FSV510.111 FSV510.111	TCV510.111 TCV510.111	DKV090 DKV090
H210.112 H310.112			FRM90/10.5 FRM90/9	DH510 DH510	DHV510 DHV510	TSV510.112 TSV510.112	FSV510 FSV510	TCV510 TCV510	DKV090 DKV090
H210 H310			FRM90/10.5 FRM90/9	DH510 DH510	DHV510 DHV510	TSV510 TSV510	FSV510 FSV510	TCV510 TCV510	DKV090 DKV090
	KM10 KM10	MB10 MB10	FRM90/10.5 FRM90/9	DH210 DH210	DHV210 DHV210	TSV210 TSV210	FSV210 FSV210		DKV090 DKV090

¹⁾ $g_T = 138$ mm at TCV510.110, TCV510.111, TCV510

²⁾ $g_V = 106$ mm at DHV510.110, DHV510.111, DHV510, DHV308, DHV210

** for temperatures > 120 °C we recommend covers DKVT...

FAG plummer block housings, split

for bearings with cylindrical bore and
for bearings with tapered bore and adapter sleeve

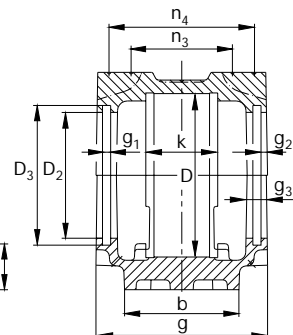
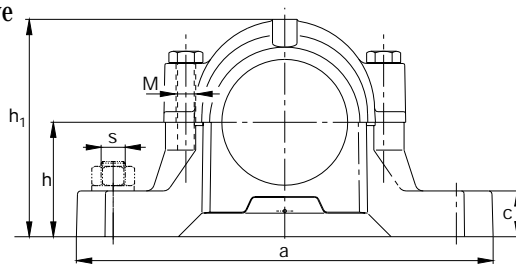
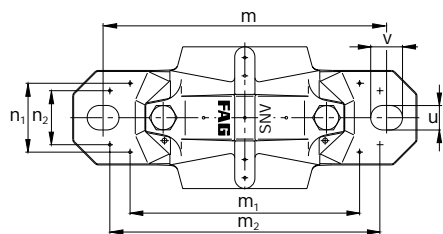

SNV100

Dimensions

D	a	b	c	g	h	m	s	u	v	h ₁	D ₂	D ₃	D ₅	
mm							mm	inch	mm					
100	255	70	28	105	70	210	M16	5/8	18	23	133	77	85.5	83.2

Shaft

d ₁ d		d ₂	Bearings which fit the housing Unsplit bearings						Split spherical roller bearing
mm	inch	mm	Codes according to DIN*						FAG
36.513	1 ⁷ / ₁₆		1309K	20309K	21309K		2309K	22309K	
38.1	1 ¹ / ₂		1309K	20309K	21309K		2309K	22309K	
39.688	1 ⁹ / ₁₆		1309K	20309K	21309K		2309K	22309K	
40			1309K	20309K	21309K		2309K	22309K	
45		55 55	6309	1309	20309	21309		2309	22309
47.625	1 ⁷ / ₈		1211K	20211K			2211K	22211K	
49.213	1 ¹⁵ / ₁₆		1211K	20211K			2211 K	22211K	
50			1211K	20211K			2211 K	22211K	
50.8	2		1211K	20211K			2211K	22211K	
55		65 65	6211	1211	20211		2211	22211	

* The order designation in the code according to DIN can be taken from the catalogue WL 41520EA „FAG Rolling Bearings“

Bearing with tapered bore and adapter sleeve

Bearing with cylindrical bore

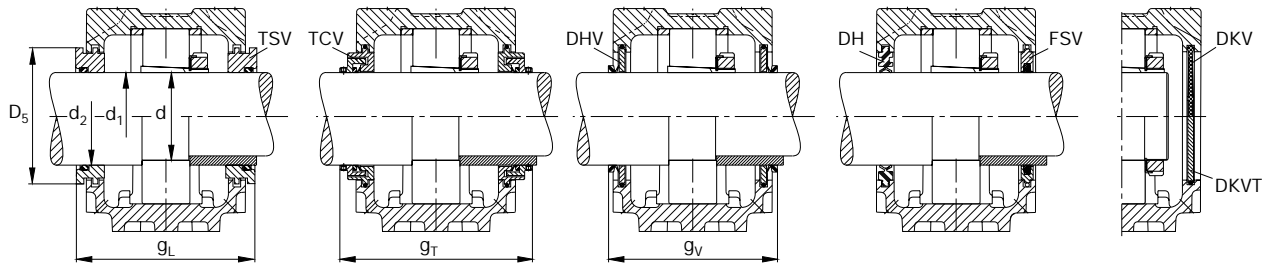

g_1	g_2	g_3	g_L	g_T	g_V	k	m_1	n_1	m_2	n_2	n_3	n_4	M DIN 931	M ₁ DIN 580	Mass ≈ kg
5	4	12.5	119	143 ¹⁾	111 ²⁾	44	170	51	200	40	62	89	M12	-	4.3

Required accessories

Adapter sleeve FAG	Locknut FAG	Lock washer FAG	Locating ring 2 pieces FAG	Two-lip seal FAG	V-ring seal FAG	Labyrinth ring with O ring FAG	Felt seal FAG	Combined seal FAG	Cover** FAG
H309.107 H2309.107			FRM100/9.5 FRM100/4	DH609.107 DH609.107	DHV609.107 DHF609.107	TSV609.107 TSV609.107	FSV609.107 FSV609.107	TCV609.107 TCV609.107	DKV100 DKV100
H309.108 H2309.108			FRM100/9.5 FRM100/4	DH609.107 DH609.107	DHV609.108 DHF609.108	TSV609.108 TSV609.108	FSV609.108 FSV609.108	TCV609.108 TCV609.108	DKV100 DKV100
H309.109 H2309.109			FRM100/9.5 FRM100/4	DH609 DH609	DHV609 DHF609	TSV609 TSV609	FSV609 FSV609	TCV609 TCV609	DKV100 DKV100
H309 H2309			FRM100/9.5 FRM100/4	DH609 DH609	DHV609 DHF609	TSV609 TSV609	FSV609 FSV609	TCV609 TCV609	DKV100 DKV100
	KM9 KM9	MB9 MB9	FRM100/9.5 FRM100/4	DH309 DH309	DHV309 DHF309	TSV309 TSV309	FSV309 FSV309		DKV100 DKV100
H211.114 H311.114			FRM100/11.5 FRM100/9.5	DH511.114 DH511.114	DHV511.114 DHF511.114	TSV511.114 TSV511.114	FSV511.114 FSV511.114	TCV511.114 TCV511.114	DKV100 DKV100
H211.115 H311.115			FRM100/11.5 FRM100/9.5	DH511 DH511	DHV511.115 DHF511.115	TSV511.115 TSV511.115	FSV511.115 FSV511.115	TCV511.115 TCV511.115	DKV100 DKV100
H211 H311			FRM100/11.5 FRM100/9.5	DH511 DH511	DHV511 DHF511	TSV511 TSV511	FSV511 FSV511	TCV511 TCV511	DKV100 DKV100
H211.200 H311.200			FRM100/11.5 FRM100/9.5	DH511 DH511	DHV511 DHF511	TSV511.200 TSV511.200	FSV511 FSV511	TCV511.200 TCV511.200	DKV100 DKV100
	KM11 KM11	MB11 MB11	FRM100/11.5 FRM100/9.5	DH211 DH211	DHV211 DHF211	TSV211 TSV211	FSV211 FSV211		DKV100 DKV100

¹⁾ $g_T = 141$ mm at TCV609.107
²⁾ $g_V = 109$ mm at DHV609.107

** for temperatures > 120 °C we recommend covers DKVT...

FAG plummer block housings, split

for bearings with cylindrical bore and
for bearings with tapered bore and adapter sleeve

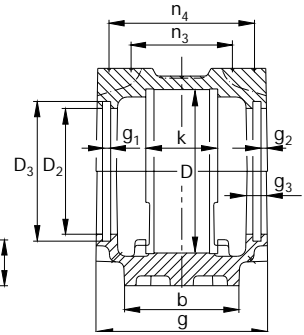
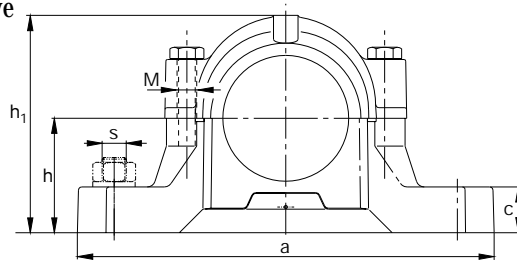
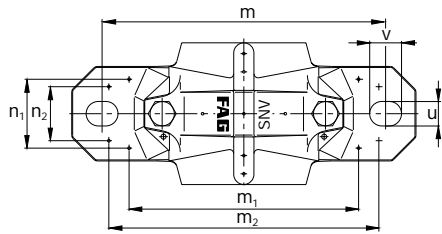

SNV110

Dimensions

D	a	b	c	g	h	m	s	u	v	h ₁	D ₂	D ₃	D ₅	
mm							mm	inch	mm					
110	255	70	30	110	70	210	M16	5/8	18	23	139	82	90.5	88.2

Shaft

d ₁	d	d ₂	Bearings which fit the housing						Split spherical roller bearing
mm	inch	mm	Codes according to DIN*						FAG
41.275	1 ⁵ / ₈		1310K	20310K	21310K	2310K	22310K		
42.863	1 ¹¹ / ₁₆		1310K	20310K	21310K	2310K	22310K		
44.45	1 ³ / ₄		1310K	20310K	21310K	2310K	22310K		
45			1310K	20310K	21310K	2310K	22310K		
50		60 60	6310	1310	20310	21310	2310	22310	
53.975	2 ¹ / ₈		1212K	20212K		2212K	22212K		
55			1212K	20212K		2212K	22212K	222SM55T	
60		70 70	6212	1212	20212	2212	22212		

* The order designation in the code according to DIN can be taken from the catalogue WL 41520EA „FAG Rolling Bearings“

Bearing with tapered bore and adapter sleeve

Bearing with cylindrical bore

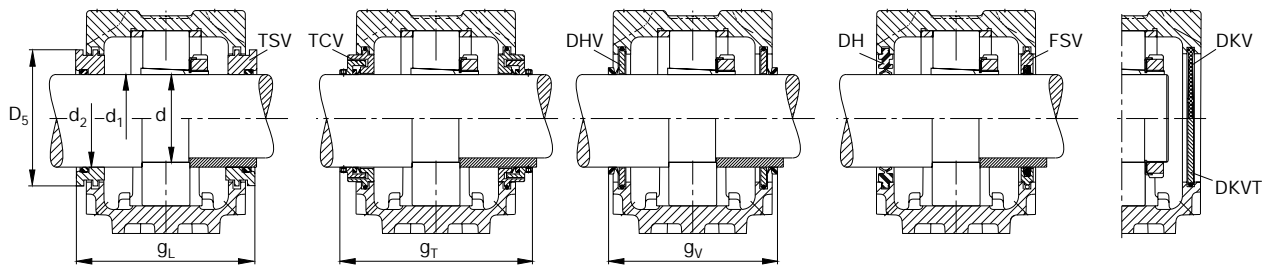

g_1	g_2	g_3	g_L	g_T	g_V	k	m_1	n_1	m_2	n_2	n_3	n_4	M DIN 931	M ₁ DIN 580	Mass ≈ kg
5	4	12.5	124	148	116 ¹⁾	48	170	52	200	40	67	94	M12	-	4.9

Required accessories

Adapter sleeve	Locknut	Lock washer	Locating ring 2 pieces	Two-lip seal	V-ring seal	Labyrinth ring with O ring	Felt seal	Combined seal	Cover**
FAG	FAG	FAG	FAG	FAG	FAG	FAG	FAG	FAG	FAG
H310.110 H2310.110			FRM110/10.5 FRM110/4	DH610.110 DH610.110	DHV610.110 DHV610.110	TSV610.110 TSV610.110	FSV610.110 FSV610.110	TCV610.110 TCV610.110	DKV110 DKV110
H310.111 H2310.111			FRM110/10.5 FRM110/4	DH610.110 DH610.110	DHV610.111 DHV610.111	TSV610.111 TSV610.111	FSV610.111 FSV610.111	TCV610.111 TCV610.111	DKV110 DKV110
H310.112 H2310.112			FRM110/10.5 FRM110/4	DH610 DH610	DHV610 DHV610	TSV610.112 TSV610.112	FSV610 FSV610	TCV610 TCV610	DKV110 DKV110
H310 H2310			FRM110/10.5 FRM110/4	DH610 DH610	DHV610 DHV610	TSV610 TSV610	FSV610 FSV610	TCV610 TCV610	DKV110 DKV110
	KM10 KM10	MB10 MB10	FRM110/10.5 FRM110/4	DH310 DH310	DHV310 DHV310	TSV310 TSV310	FSV310 FSV310		DKV110 DKV110
H212.202 H312.202			FRM110/13 FRM110/10	DH512 DH512	DHV512 DHV512	TSV512.202 TSV512.202	FSV512.202 FSV512.202	TCV512.202 TCV512.202	DKV110 DKV110
H212 H312			FRM110/13 FRM110/10 FRM110/10	DH512 DH512 DH512	DHV512 DHV512 DHV512	TSV512 TSV512 TSV512	FSV512 FSV512 FSV512	TCV512 TCV512 TCV512	DKV110 DKV110 DKV110
	KM12 KM12	MB12 MB12	FRM110/13 FRM110/10	DH212 DH212	DHV212 DHV212	TSV212 TSV212	FSV212 FSV212		DKV110 DKV110

¹⁾ $g_V = 120$ mm at DHV212

** for temperatures > 120 °C we recommend covers DKVT...

FAG plummer block housings, split

for bearings with cylindrical bore and
for bearings with tapered bore and adapter sleeve

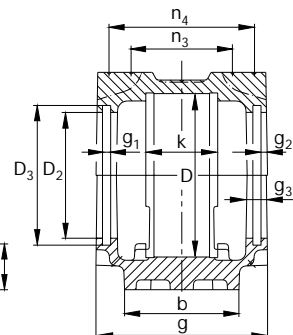
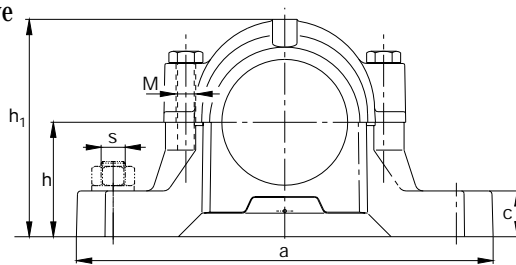
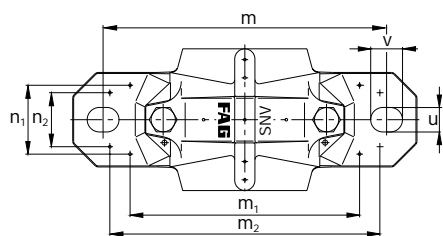

SNV120

Dimensions

D	a	b	c	g	h	m	s	u	v	h ₁	D ₂	D ₃	D ₅	
mm							mm	inch	mm					
120	275	80	30	115	80	230	M16	5/8	18	23	155	87	95.5	93.2

Shaft

d ₁ d		d ₂	Bearings which fit the housing						Split spherical roller bearing
mm	inch	mm	Codes according to DIN*						FAG
47.625	1 ⁷ / ₈		1311K	20311K	21311K	2311K	22311K		
49.213	1 ¹⁵ / ₁₆		1311K	20311K	21311K	2311K	22311K		
50			1311K	20311K	21311K	2311K	22311K		
50.8	2		1311K	20311K	21311K	2311K	22311K		
55		65 65	6311	1311	20311	21311	2311	22311	
55.563	2 ³ / ₁₆		1213K	20213K		2213K	22213K	222S.203	
57.15	2 ¹ / ₄		1213K	20213K		2213K	22213K	222S.204	
60			1213K	20213K		2213K	22213K		
60.325	2 ³ / ₈		1213K	20213K		2213K	22213K		
65		75 75	6213	1213	20213	2213	22213		

* The order designation in the code according to DIN can be taken from the catalogue WL 41520EA „FAG Rolling Bearings“

Bearing with tapered bore and adapter sleeve

Bearing with cylindrical bore

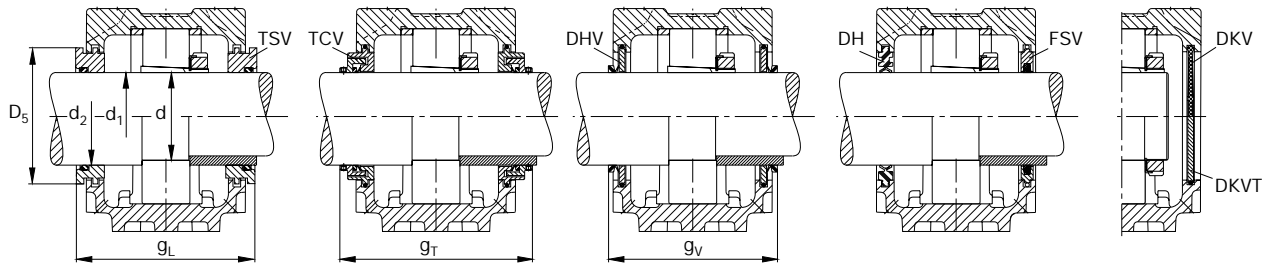

g_1	g_2	g_3	g_L	g_T	g_V	k	m_1	n_1	m_2	n_2	n_3	n_4	M DIN 931	M ₁ DIN 580	Mass ≈ kg
5	4	12.5	129	153	121 ¹⁾	51	190	58	220	48	71	99	M12	-	6.1

Required accessories

Adapter sleeve FAG	Locknut FAG	Lock washer FAG	Locating ring 2 pieces FAG	Two-lip seal FAG	V-ring seal FAG	Labyrinth ring with O ring FAG	Felt seal FAG	Combined seal FAG	Cover** FAG
H311.114 H2311.114			FRM120/11 FRM120/4	DH611.114 DH611.114	DHV611.114 DHV611.114	TSV611.114 TSV611.114	FSV611.114 FSV611.114	TCV611.114 TCV611.114	DKV120 DKV120
H311.115 H2311.115			FRM120/11 FRM120/4	DH611 DH611	DHV611.115 DHV611.115	TSV611.115 TSV611.115	FSV611.115 FSV611.115	TCV611.115 TCV611.115	DKV120 DKV120
H311 H2311			FRM120/11 FRM120/4	DH611 DH611	DHV611 DHV611	TSV611 TSV611	FSV611 FSV611	TCV611 TCV611	DKV120 DKV120
H311.200 H2311.200			FRM120/11 FRM120/4	DH611 DH611	DHV611 DHV611	TSV611.200 TSV611.200	FSV611 FSV611	TCV611.200 TCV611.200	DKV120 DKV120
	KM11 KM11	MB11 MB11	FRM120/11 FRM120/4	DH311 DH311	DHV311 DHV311	TSV311 TSV311	FSV311 FSV311		DKV120 DKV120
H213.203 H313.203			FRM120/14 FRM120/10 FRM120/10	DH513.203 DH513.203 DH513.203	DHV513.203 DHV513.203 DHV513.203	TSV513.203 TSV513.203 TSV513.203	FSV513.203 FSV513.203 FSV513.203	TCV513.203 TCV513.203 TCV513.203	DKV120 DKV120 DKV120
H213.204 H313.204			FRM120/14 FRM120/10 FRM120/10	DH513.203 DH513.203 DH513.203	DHV513.204 DHV513.204 DHV513.204	TSV513.204 TSV513.204 TSV513.204	FSV513.204 FSV513.204 FSV513.204	TCV513.204 TCV513.204 TCV513.204	DKV120 DKV120 DKV120
H213 H313			FRM120/14 FRM120/10	DH513 DH513	DHV513 DHV513	TSV513 TSV513	FSV513 FSV513	TCV513 TCV513	DKV120 DKV120
H213.206 H313.206			FRM120/14 FRM120/10	DH513 DH513	DHV513 DHV513	TSV513 TSV513	FSV513 FSV513	TCV513 TCV513	DKV120 DKV120
	KM13 KM13	MB13 MB13	FRM120/14 FRM120/10	DH213 DH213	DHV213 DHV213	TSV213 TSV213	FSV213 FSV213		DKV120 DKV120

¹⁾ $g_V = 125$ mm at DHV213

** for temperatures > 120 °C we recommend covers DKVT...

FAG plummer block housings, split

for bearings with cylindrical bore and
for bearings with tapered bore and adapter sleeve

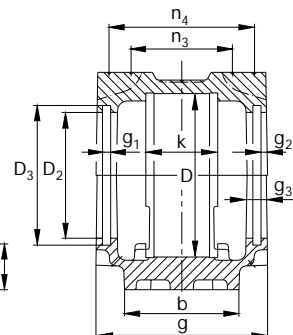
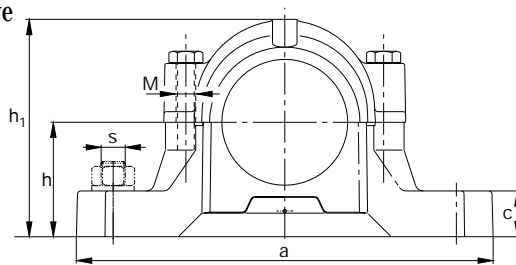
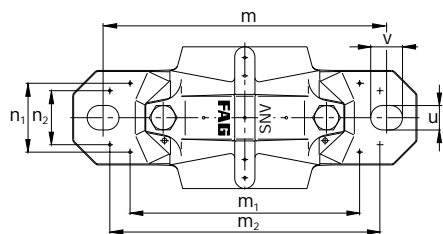

SNV125

Dimensions

D	a	b	c	g	h	m	s	u	v	h ₁	D ₂	D ₃	D ₅	
mm							mm	inch	mm					
125	275	80	30	105	80	230	M16	5/8	18	23	158	112	120.5	118.2

Shaft

d ₁	d	d ₂	Bearings which fit the housing				Split spherical roller bearing		
mm	inch	mm	Codes according to DIN*				FAG		
70		80	6214	1214	20214			2214	22214
		80							

* The order designation in the code according to DIN can be taken from the catalogue WL 41520EA „FAG Rolling Bearings“

Bearing with tapered bore and adapter sleeve

Bearing with cylindrical bore

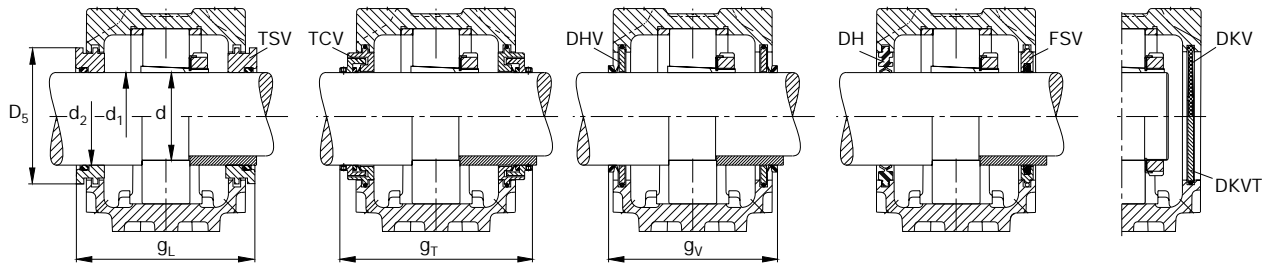

g_1	g_2	g_3	g_L	g_T	g_V	k	m_1	n_1	m_2	n_2	n_3	n_4	M DIN 931	M ₁ DIN 580	Mass ≈ kg
5	5.25	15	120.3	143	110	39	190	52	220	48	57	86	M12	-	6.5

Required accessories

Adapter sleeve	Locknut	Lock washer	Locating ring 2 pieces	Two-lip seal	V-ring seal	Labyrinth ring with O ring	Felt seal	Combined seal	Cover**
FAG	FAG	FAG	FAG	FAG	FAG	FAG	FAG	FAG	FAG
	KM14	MB14	FRM125/7.5	DH214	DHV214	TSV214	FSV214	TCV214	DKV150
	KM14	MB14	FRM125/4	DH214	DHV214	TSV214	FSV214	TCV214	DKV150

** for temperatures > 120 °C we recommend covers DKVT...

FAG plummer block housings, split

for bearings with cylindrical bore and
for bearings with tapered bore and adapter sleeve

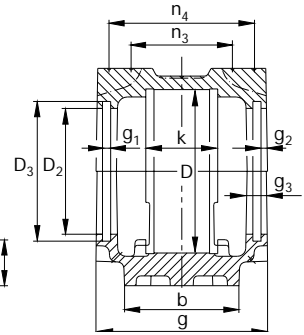
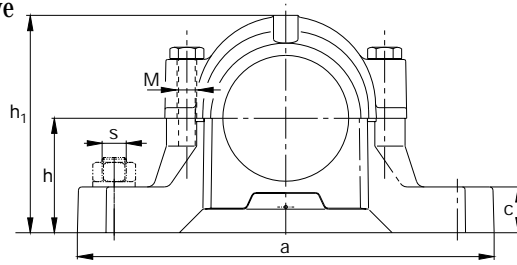
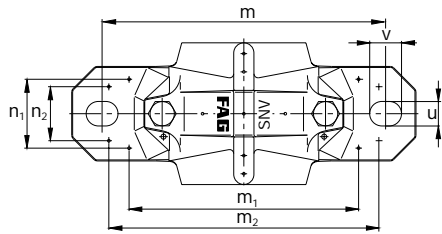

SNV130

Dimensions

D	a	b	c	g	h	m	s	u	v	h ₁	D ₂	D ₃	D ₅	
mm							mm	inch	mm					
130	280	80	30	120	80	230	M16	5/8	18	23	161	102.5	111	108.7

Shaft

d ₁	d	d ₂	Bearings which fit the housing						Split spherical roller bearing
mm	inch	mm	Codes according to DIN*						FAG
53.975	2 ¹ / ₈		1312K	20312K	21312K	2312K	22312K		
55			1312K	20312K	21312K	2312K	22312K		
60		70 70	6312	1312	20312	21312	2312	22312	
61.913	2 ⁷ / ₁₆		1215K	20215K		2215K	22215K	222S.207	
63.5	2 ¹ / ₂		1215K	20215K		2215K	22215K	222S.208	
65			1215K	20215K		2215K	22215K	222SM65T	
66.675	2 ⁵ / ₈		1215K	20215K		2215K	22215K		
75		85 85	6215	1215	20215	2215	22215		

* The order designation in the code according to DIN can be taken from the catalogue WL 41520EA „FAG Rolling Bearings“

Bearing with tapered bore and adapter sleeve

Bearing with cylindrical bore

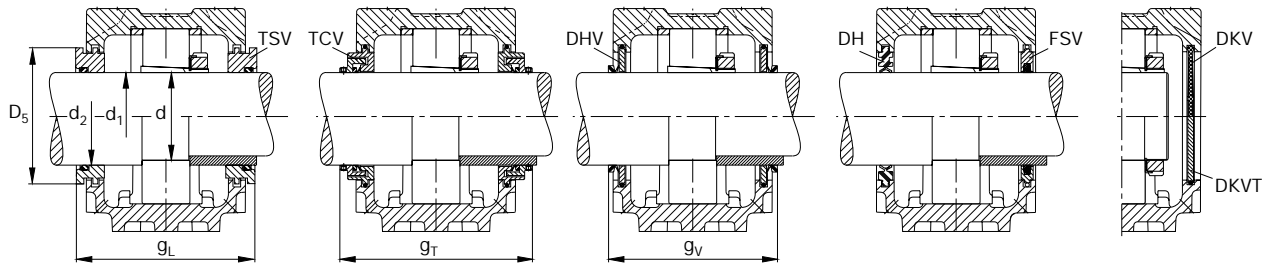

g_1	g_2	g_3	g_L	g_T	g_V	k	m_1	n_1	m_2	n_2	n_3	n_4	M DIN 931	M_1 DIN 580	Mass ≈ kg
5	4	12.5	134	158	126 ¹⁾	56	190	60	220	48	76	104	M12	-	6.8

Required accessories

Adapter sleeve	Locknut	Lock washer	Locating ring 2 pieces	Two-lip seal	V-ring seal	Labyrinth ring with O ring	Felt seal	Combined seal	Cover**
FAG	FAG	FAG	FAG	FAG	FAG	FAG	FAG	FAG	FAG
H312.202 H2312.202			FRM130/12.5 FRM130/5	DH612 DH612	DHV612 DHV612	TSV612.202 TSV612.202	FSV612.202 FSV612.202	TCV612.202 TCV612.202	DKV130 DKV130
H312 H2312			FRM130/12.5 FRM130/5	DH612 DH612	DHV612 DHV612	TSV612 TSV612	FSV612 FSV612	TCV612 TCV612	DKV130 DKV130
	KM12 KM12	MB12 MB12	FRM130/12.5 FRM130/5	DH312 DH312	DHV312 DHV312	TSV312 TSV312	FSV312 FSV312	TCV312 TCV312	DKV130 DKV130
H215.207 H315.207			FRM130/15.5 FRM130/12.5 FRM130/12.5	DH515.207 DH515.207 DH515.207	DHV515.207 DHV515.207 DHV515.207	TSV515.207 TSV515.207 TSV515.207	FSV515.207 FSV515.207 FSV515.207	TCV515.207 TCV515.207 TCV515.207	DKV130 DKV130 DKV130
H215.208 H315.208			FRM130/15.5 FRM130/12.5 FRM130/12.5	DH515.207 DH515.207 DH515.207	DHV515.208 DHV515.208 DHV515.208	TSV515.208 TSV515.208 TSV515.208	FSV515.208 FSV515.208 FSV515.208	TCV515.208 TCV515.208 TCV515.208	DKV130 DKV130 DKV130
H215 H315			FRM130/15.5 FRM130/12.5 FRM130/12.5	DH515 DH515 DH515	DHV515 DHV515 DHV515	TSV515 TSV515 TSV515	FSV515 FSV515 FSV515	TCV515 TCV515 TCV515	DKV130 DKV130 DKV130
H215.210 H315.210			FRM130/15.5 FRM130/12.5	DH515 DH515	DHV515.210 DHV515.210	TSV515.210 TSV515.210	FSV515.210 FSV515.210	TCV515.210 TCV515.210	DKV130 DKV130
	KM15 KM15	MB15 MB15	FRM130/15.5 FRM130/12.5	DH215 DH215	DHV215 DHV215	TSV215 TSV215	FSV215 FSV215		DKV130 DKV130

¹⁾ $g_V = 130$ mm at DHV312 and DHV215

** for temperatures > 120 °C we recommend covers DKVT...

FAG plummer block housings, split

for bearings with cylindrical bore and
for bearings with tapered bore and adapter sleeve

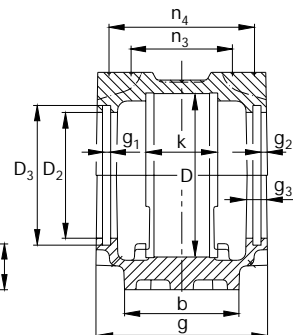
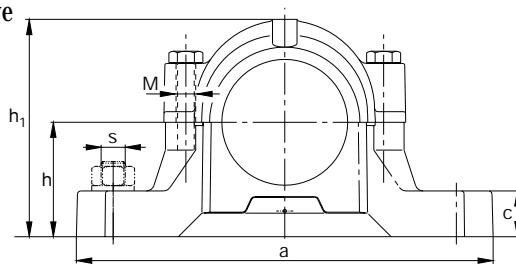
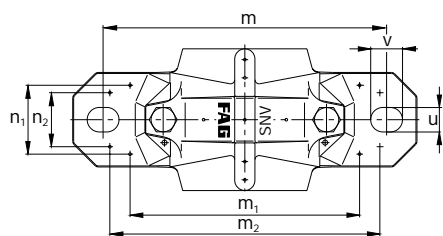

SNV140

Dimensions

D	a	b	c	g	h	m	s	u	v	h ₁	D ₂	D ₃	D ₅	
mm							mm	inch	mm					
140	315	90	32	135	95	260	M20	³ / ₄	22	27	183	108	116.5	114.2

Shaft

d ₁	d	d ₂	Bearings which fit the housing						Split spherical roller bearing
mm	inch	mm	Codes according to DIN*						FAG
55.563	2 ³ / ₁₆		1313K	20313K	21313K	2313K	22313K		
57.15	2 ¹ / ₄		1313K	20313K	21313K	2313K	22313K		
60			1313K	20313K	21313K	2313K	22313K		
60.325	2 ³ / ₈		1313K	20313K	21313K	2313K	22313K		
65		75 75	6313	1313	20313	21313	2313	22313	
68.263	2 ¹¹ / ₁₆		1216K	20216K		2216K	22216K	222S.211	
69.85	2 ³ / ₄		1216K	20216K		2216K	22216K		
70			1216K	20216K		2216K	22216K	222SM70T	
73.025	2 ⁷ / ₈		1216K	20216K		2216K	22216K		
80		90 90	6216	1216	20216	2216	22216		

* The order designation in the code according to DIN can be taken from the catalogue WL 41520EA „FAG Rolling Bearings“

Bearing with tapered bore and adapter sleeve

Bearing with cylindrical bore

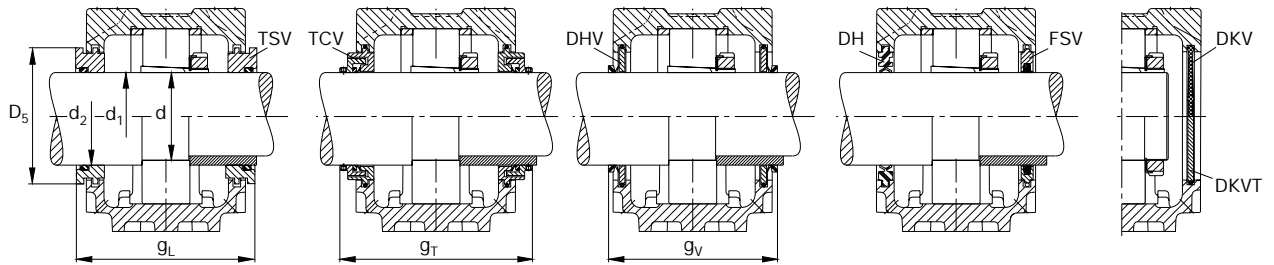

g_1	g_2	g_3	g_L	g_T	g_V	k	m_1	n_1	m_2	n_2	n_3	n_4	M DIN 931	M ₁ DIN 580	Mass ≈ kg
5	5.25	15	150.3	172 ¹⁾	139 ²⁾	58	210	65	252	52	81	117	M12	-	9.3

Required accessories

Adapter sleeve FAG	Locknut FAG	Lock washer FAG	Locating ring 2 pieces FAG	Two-lip seal FAG	V-ring seal FAG	Labyrinth ring with O ring FAG	Felt seal FAG	Combined seal FAG	Cover** FAG
H313.203 H2313.203			FRM140/12.5 FRM140/5	DH613.203 DH613.203	DHV613.203 DHV613.203	TSV613.203 TSV613.203	FSV613.203 FSV613.203	TCV613.203 TCV613.203	DKV140 DKV140
H313.204 H2313.204			FRM140/12.5 FRM140/5	DH613.203 DH613.203	DHV613.204 DHV613.204	TSV613.204 TSV613.204	FSV613.204 FSV613.204	TCV613.204 TCV613.204	DKV140 DKV140
H313 H2313			FRM140/12.5 FRM140/5	DH613 DH613	DHV613 DHV613	TSV613 TSV613	FSV613 FSV613	TCV613 TCV613	DKV140 DKV140
H313.206 H2313.206			FRM140/12.5 FRM140/5	DH613 DH613	DHV613 DHV613	TSV613 TSV613	FSV613 FSV613	TCV613 TCV613	DKV140 DKV140
	KM13 KM13	MB13 MB13	FRM140/12.5 FRM140/5	DH313 DH313	DHV313 DHV313	TSV313 TSV313	FSV313 FSV313	TCV313 TCV313	DKV140 DKV140
H216.211 H316.211			FRM140/16 FRM140/12.5 FRM140/12.5	DH516.211 DH516.211 DH516.211	DHV516.211 DHV516.211 DHV516.211	TSV516.211 TSV516.211 TSV516.211	FSV516.211 FSV516.211 FSV516.211	TCV516.211 TCV516.211 TCV516.211	DKV140 DKV140 DKV140
H216.212 H316.212			FRM140/16 FRM140/12.5	DH516 DH516	DHV516 DHV516	TSV516 TSV516	FSV516 FSV516	TCV516 TCV516	DKV140 DKV140
H216 H316			FRM140/16 FRM140/12.5 FRM140/12.5	DH516 DH516 DH516	DHV516 DHV516 DHV516	TSV516 TSV516 TSV516	FSV516 FSV516 FSV516	TCV516 TCV516 TCV516	DKV140 DKV140 DKV140
H216.214 H316.214			FRM140/16 FRM140/12.5	DH516.214 DH516.214	DHV516.214 DHV516.214	TSV516.214 TSV516.214	FSV516.214 FSV516.214	TCV516.214 TCV516.214	DKV140 DKV140
	KM16 KM16	MB16 MB16	FRM140/16 FRM140/12.5	DH216 DH216	DHV216 DHV216	TSV216 TSV216	FSV216 FSV216		DKV140 DKV140

¹⁾ g_T = 176 mm at TCV516.211, TCV516, TCV516.214;
 g_T = 175.5 mm at TCV313
²⁾ g_V = 143 mm at DHV516.211, DHV516, DHV516.214
 g_V = 142.5 mm at DHV313 and DHV216

** for temperatures > 120 °C we recommend covers DKVT...

FAG plummer block housings, split

for bearings with cylindrical bore and
for bearings with tapered bore and adapter sleeve

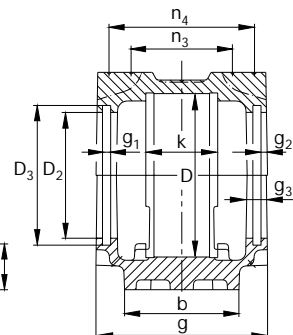
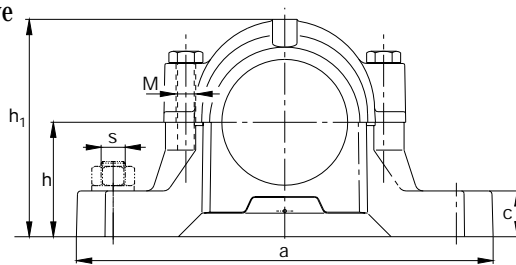
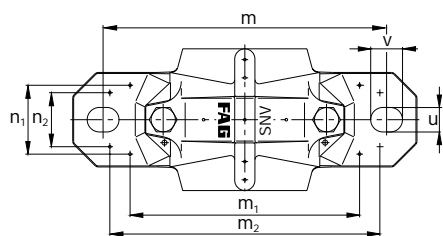

SNV150

Dimensions

D	a	b	c	g	h	m	s	u	v	h ₁	D ₂	D ₃	D ₅	
mm							mm	inch	mm					
150	320	90	32	140	95	260	M20	³ / ₄	22	27	189	112	120.5	118.2

Shaft

d ₁	d	d ₂	Bearings which fit the housing						Split spherical roller bearing
mm	inch	mm	Codes according to DIN*						FAG
70		80 80	6314	1314	20314	21314	2314	22314	
74.613	2 ¹⁵ / ₁₆			1217K	20217K		2217K	22217K	222S.215
75				1217K	20217K		2217K	22217K	222SM75T
76.2	3			1217K	20217K		2217K	22217K	222S.300
85		95 95	6217	1217	20217		2217	22217	

* The order designation in the code according to DIN can be taken from the catalogue WL 41520EA „FAG Rolling Bearings“

Bearing with tapered bore and adapter sleeve

Bearing with cylindrical bore

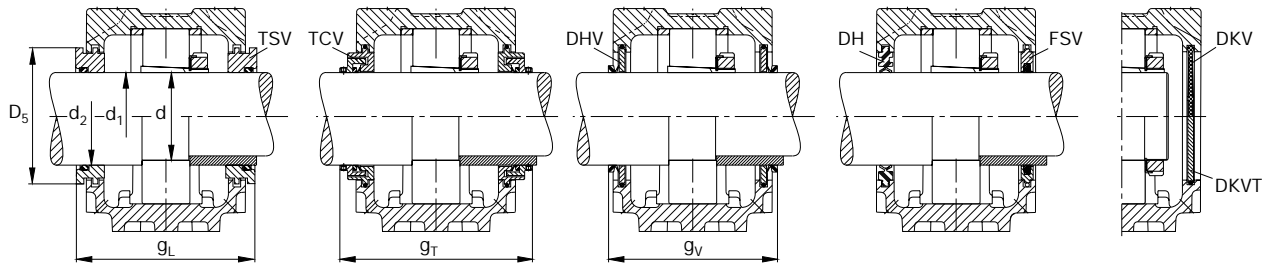

g_1	g_2	g_3	g_L	g_T	g_V	k	m_1	n_1	m_2	n_2	n_3	n_4	M DIN 931	M ₁ DIN 580	Mass ≈ kg
5	5.25	15	155.3	181 ¹⁾	148 ²⁾	61	210	66	252	52	85	122	M12	-	9.9

Required accessories

Adapter sleeve FAG	Locknut FAG	Lock washer FAG	Locating ring 2 pieces FAG	Two-lip seal FAG	V-ring seal FAG	Labyrinth ring with O ring FAG	Felt seal FAG	Combined seal FAG	Cover** FAG
	KM14	MB14	FRM150/13	DH214	DHV214	TSV214	FSV214	TCV214	DKV150
	KM14	MB14	FRM150/5	DH214	DHV214	TSV214	FSV214	TCV214	DKV150
H217.215 H317.215			FRM150/16.5 FRM150/12.5 FRM150/12.5	DH517 DH517 DH517	DHV517 DHV517 DHV517	TSV517 TSV517 TSV517	FSV517 FSV517 FSV517	TCV517 TCV517 TCV517	DKV150 DKV150 DKV150
H217 H317			FRM150/16.5 FRM150/12.5 FRM150/12.5	DH517 DH517 DH517	DHV517 DHV517 DHV517	TSV517 TSV517 TSV517	FSV517 FSV517 FSV517	TCV517 TCV517 TCV517	DKV150 DKV150 DKV150
H217.300 H317.300			FRM150/16.5 FRM150/12.5 FRM150/12.5	DH517 DH517 DH517	DHV517.300 DHV517.300 DHV517.300	TSV517.300 TSV517.300 TSV517.300	FSV517.300 FSV517.300 FSV517.300	TCV517.300 TCV517.300 TCV517.300	DKV150 DKV150 DKV150
	KM17	MB17	FRM150/16.5 FRM150/12.5	DH217 DH217	DHV217 DHV217	TSV217 TSV217	FSV217 FSV217		DKV150 DKV150

¹⁾ $g_T = 180.5$ mm at TCV214
²⁾ $g_V = 147.5$ mm at DHV214;
 $g_V = 137.5$ mm at DHV217

** for temperatures > 120 °C we recommend covers DKVT...

FAG plummer block housings, split

for bearings with cylindrical bore and
for bearings with tapered bore and adapter sleeve

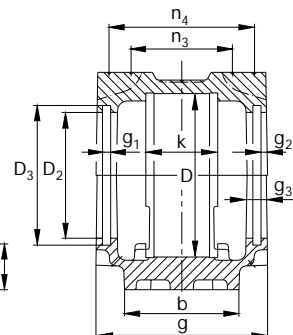
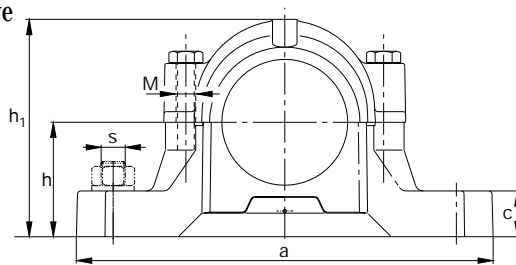
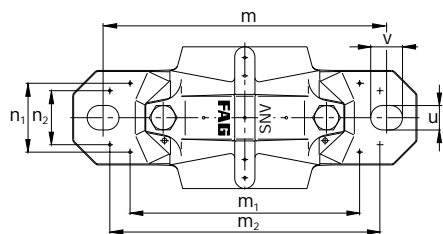

SNV160

Dimensions

D	a	b	c	g	h	m	s	u	v	h ₁	D ₂	D ₃	D ₅	
mm							mm	inch	mm					
160	345	100	35	145	100	290	M20	3/4	22	27	201	120	128.5	125.7

Shaft

d ₁ d		d ₂	Bearings which fit the housing Unsplit bearings						Split spherical roller bearing
mm	inch	mm	Codes according to DIN*						FAG
61.913	2⁷/₁₆		1315K	20315K	21315K	2315K	22315K		
63.5	2¹/₂		1315K	20315K	21315K	2315K	22315K		
65			1315K	20315K	21315K	2315K	22315K		
66.675	2⁵/₈		1315K	20315K	21315K	2315K	22315K		
75		85 85	6315	1315	20315	21315	2315	22315	
79.375	3¹/₈		1218K	20218K		2218K	22218K	23218K	
80			1218K	20218K		2218K	22218K	23218K	
								222SM80T	
80.963	3³/₁₆		1218K	20218K		2218K	22218K	23218K	
								222S.303	
82.55	3¹/₄		1218K	20218K		2218K	22218K	23218K	
								222S.304	
90		100 100 100	6218	1218	20218	2218	22218	23218	

* The order designation in the code according to DIN can be taken from the catalogue WL 41520EA „FAG Rolling Bearings“

Bearing with tapered bore and adapter sleeve

Bearing with cylindrical bore

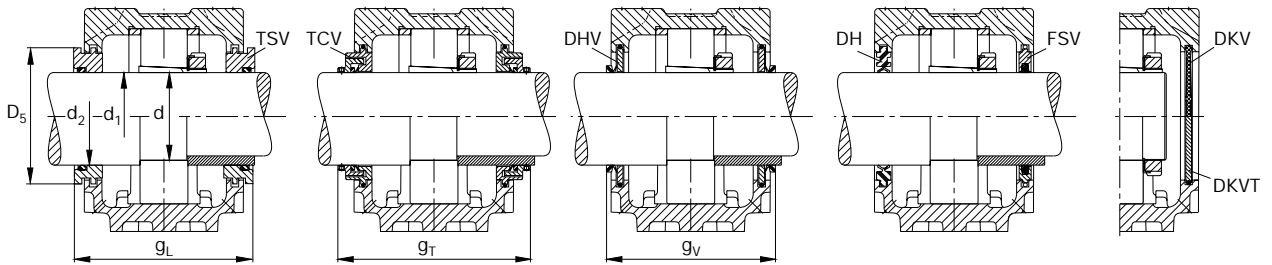

g_1	g_2	g_3	g_L	g_T	g_V	k	m_1	n_1	m_2	n_2	n_3	n_4	M DIN 931	M ₁ DIN 580	Mass ≈ kg
5	5.25	15	160.3	182 ¹⁾	149 ²⁾	65	240	72	280	58	90	127	M16	-	12.8

Required accessories

Adapter sleeve FAG	Locknut FAG	Lock washer FAG	Locating ring 2 pieces FAG	Two-lip seal FAG	V-ring seal FAG	Labyrinth ring with O ring FAG	Felt seal FAG	Combined seal FAG	Cover** FAG
H315.207 H2315.207			FRM160/14 FRM160/5	DH615.207 DH615.207	DHV615.207 DHV615.207	TSV615.207 TSV615.207	FSV615.207 FSV615.207	TCV615.207 TCV615.207	DKV160 DKV160
H315.208 H2315.208			FRM160/14 FRM160/5	DH615.207 DH615.207	DHV615.208 DHV615.208	TSV615.208 TSV615.208	FSV615.208 FSV615.208	TCV615.208 TCV615.208	DKV160 DKV160
H315 H2315			FRM160/14 FRM160/5	DH615 DH615	DHV615 DHV615	TSV615 TSV615	FSV615 FSV615	TCV615 TCV615	DKV160 DKV160
H315.210 H2315.210			FRM160/14 FRM160/5	DH615 DH615	DHV615.210 DHV615.210	TSV615.210 TSV615.210	FSV615.210 FSV615.210	TCV615.210 TCV615.210	DKV160 DKV160
	KM15 KM15	MB15 MB15	FRM160/14 FRM160/5	DH315 DH315	DHV315 DHV315	TSV315 TSV315	FSV315 FSV315	TCV315 TCV315	DKV160 DKV160
H218.302 H318.302 H2318.302			FRM160/17,5 FRM160/12,5 FRM160/6,3	DH518 DH518 DH518	DHV518 DHV518 DHV518	TSV518.302 TSV518.302 TSV518.302	FSV518 FSV518 FSV518	TCV518.302 TCV518.302 TCV518.302	DKV160 DKV160 DKV160
H218 H318			FRM160/17,5 FRM160/12,5 FRM160/12,5	DH518 DH518 DH518	DHV518 DHV518 DHV518	TSV518 TSV518 TSV518	FSV518 FSV518 FSV518	TCV518 TCV518 TCV518	DKV160 DKV160 DKV160
H2318			FRM160/6,3	DH518	DHV518	TSV518	FSV518	TCV518	DKV160
H218.303 H318.303			FRM160/17,5 FRM160/12,5	DH518 DH518	DHV518.303 DHV518.303	TSV518.303 TSV518.303	FSV518.303 FSV518.303	TCV518.303 TCV518.303	DKV160 DKV160
H2318.303			FRM160/12,5 FRM160/6,3	DH518 DH518	DHV518.303 DHV518.303	TSV518.303 TSV518.303	FSV518.303 FSV518.303	TCV518.303 TCV518.303	DKV160 DKV160
H218.304 H318.304			FRM160/17,5 FRM160/12,5	DH518.304 DH518.304	DHV518.304 DHV518.304	TSV518.304 TSV518.304	FSV518.304 FSV518.304	TCV518.304 TCV518.304	DKV160 DKV160
H2318.304			FRM160/12,5 FRM160/6,3	DH518.304 DH518.304	DHV518.304 DHV518.304	TSV518.304 TSV518.304	FSV518.304 FSV518.304	TCV518.304 TCV518.304	DKV160 DKV160
	KM18 KM18 KM18	MB18 MB18 MB18	FRM160/17,5 FRM160/12,5 FRM160/6,3	DH218 DH218 DH218	DHV218 DHV218 DHV218	TSV218 TSV218 TSV218	FSV218 FSV218 FSV218		DKV160 DKV160 DKV160

¹⁾ $g_T = 186$ mm at TCV518.302, TCV518, TCV518.303, TCV518.304;

²⁾ $g_T = 185.5$ mm at TCV315

²⁾ $g_V = 153$ mm at DHV518, DHV518.303, DHV518.304;

$g_V = 152.5$ mm at DHV315 and DHV218

** for temperatures > 120 °C we recommend covers DKVT...

FAG plummer block housings, split

for bearings with cylindrical bore and
for bearings with tapered bore and adapter sleeve

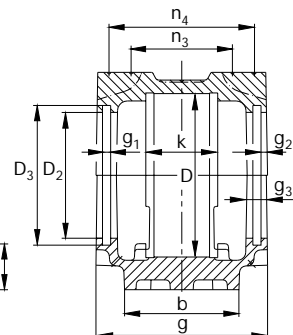
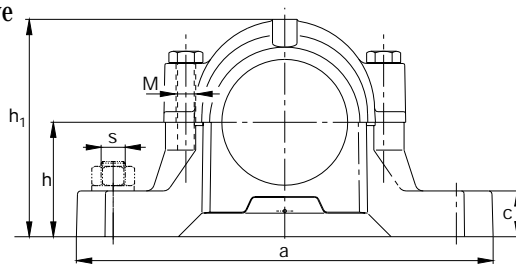
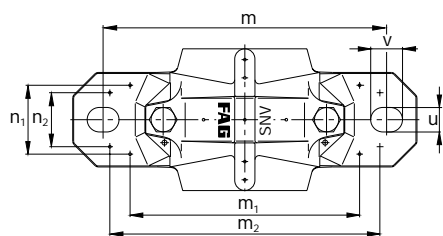

SNV170

Dimensions

D	a	b	c	g	h	m	s	u	v	h ₁	D ₂	D ₃	D ₅	
mm							mm	inch	mm					
170	345	100	35	150	112	290	M20	³ / ₄	22	27	219	131	141	138.2

Shaft

d ₁	d	d ₂	Bearings which fit the housing						Split spherical roller bearing
mm	inch	mm	Codes according to DIN*						FAG
68.263	2¹¹/₁₆		1316K	20316K	21316K	2316K	22316K		
69.85	2³/₄		1316K	20316K	21316K	2316K	22316K		
70			1316K	20316K	21316K	2316K	22316K		
73.025	2⁷/₈		1316K	20316K	21316K	2316K	22316K		
80		90 90	6316	1316	20316	21316	2316	22316	
85			1219K	20219K		2219K	22219K	222SM85T	
85.725	3³/₈		1219K	20219K		2219K	22219K		
95		110 110	6219	1219	20219	2219	22219		

* The order designation in the code according to DIN can be taken from the catalogue WL 41520EA „FAG Rolling Bearings“

Bearing with tapered bore and adapter sleeve

Bearing with cylindrical bore

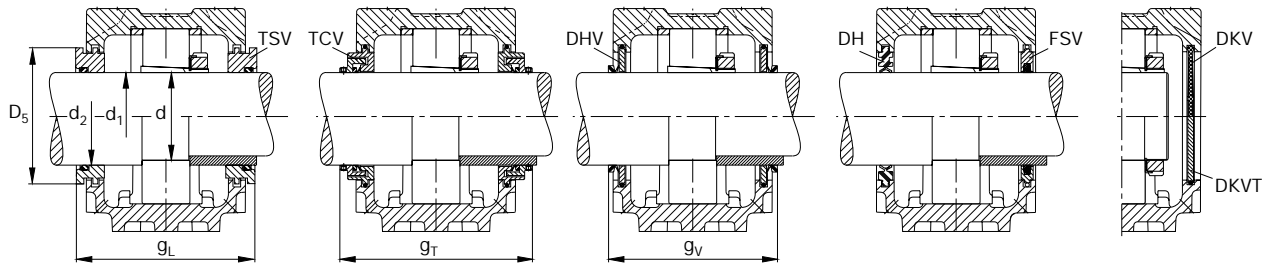

g_1	g_2	g_3	g_L	g_T	g_V	k	m_1	n_1	m_2	n_2	n_3	n_4	M DIN 931	M ₁ DIN 580	Mass ≈ kg
6	5.25	16	167.3	193 ¹⁾	158 ²⁾	68	240	74	280	58	93	132	M16	-	14.4

Required accessories

Adapter sleeve FAG	Locknut FAG	Lock washer FAG	Locating ring 2 pieces FAG	Two-lip seal FAG	V-ring seal FAG	Labyrinth ring with O ring FAG	Felt seal FAG	Combined seal FAG	Cover** FAG
H316.211 H2316.211			FRM170/14.5 FRM170/5	DH616.211 DH616.211	DHV616.211 DHV616.211	TSV616.211 TSV616.211	FSV616.211 FSV616.211	TCV616.211 TCV616.211	DKV170 DKV170
H316.212 H2316.212			FRM170/14.5 FRM170/5	DH616 DH616	DHV616 DHV616	TSV616 TSV616	FSV616 FSV616	TCV616 TCV616	DKV170 DKV170
H316 H2316			FRM170/14.5 FRM170/5	DH616 DH616	DHV616 DHV616	TSV616 TSV616	FSV616 FSV616	TCV616 TCV616	DKV170 DKV170
H316.214 H2316.214			FRM170/14.5 FRM170/5	DH616.214 DH616.214	DHV616.214 DHV616.214	TSV616.214 TSV616.214	FSV616.214 FSV616.214	TCV616.214 TCV616.214	DKV170 DKV170
	KM16 KM16	MB16 MB16	FRM170/14.5 FRM170/5	DH316 DH316	DHV316 DHV316	TSV316 TSV316	FSV316 FSV316	TCV316 TCV316	DKV170 DKV170
H219 H319			FRM170/18 FRM170/12.5 FRM170/12.5	DH519 DH519 DH519	DHV519 DHV519 DHV519	TSV519 TSV519 TSV519	FSV519 FSV519 FSV519	TCV519 TCV519 TCV519	DKV170 DKV170 DKV170
H219.306 H319.306			FRM170/18 FRM170/12.5	DH519 DH519	DHV519 DHV519	TSV519.306 TSV519.306	FSV519 FSV519	TCV519.306 TCV519.306	DKV170 DKV170
	KM19 KM19	MB19 MB19	FRM170/18 FRM170/12.5	DH219 DH219	DHV219 DHV219	TSV219 TSV219	FSV219 FSV219		DKV170 DKV170

¹⁾ $g_T = 192.5$ mm at TCV316
²⁾ $g_V = 157.5$ mm at DHV316
 $g_V = 160.5$ mm at DHV219

** for temperatures > 120 °C we recommend covers DKVT...

FAG plummer block housings, split

for bearings with cylindrical bore and
for bearings with tapered bore and adapter sleeve

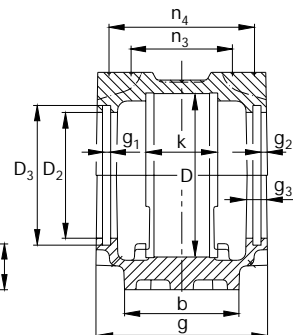
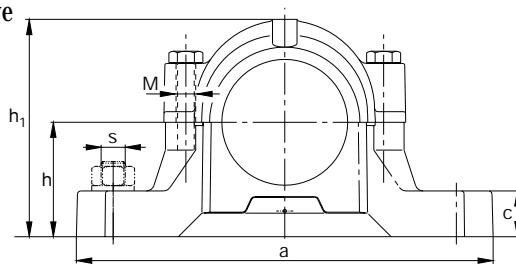
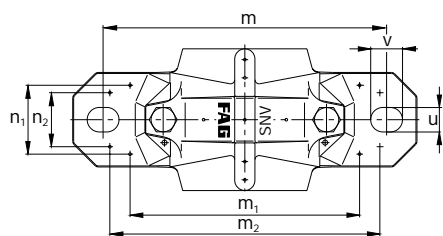

SNV180

Dimensions

D	a	b	c	g	h	m	s	u	v	h ₁	D ₂	D ₃	D ₅	
mm							mm	inch	mm					
180	380	110	40	160	112	320	M24	7/8	26	32	223	137.5	147.5	144.7

Shaft

d ₁ d		d ₂	Bearings which fit the housing						Split spherical roller bearing
mm	inch	mm	Codes according to DIN*						FAG
74.613	2¹⁵/₁₆		1317K	20317K	21317K	2317K	22317K		
75			1317K	20317K	21317K	2317K	22317K		
76.2	3		1317K	20317K	21317K	2317K	22317K		
85		95 95	6317	1317	20317	21317	2317	22317	
87.313	3⁷/₁₆		1220K	20220K		2220K	22220K	23220K	222S.307
88.9	3¹/₂		1220K	20220K		2220K	22220K	23220K	222S.308
90			1220K	20220K		2220K	22220K	23220K	222SM90T
92.075	3⁵/₈		1220K	20220K		2220K	22220K	23220K	
93.663	3¹¹/₁₆		1220K	20220K		2220K	22220K	23220K	
100		115 115 115	6220	1220	20220	2220	22220	23220	

* The order designation in the code according to DIN can be taken from the catalogue WL 41520EA „FAG Rolling Bearings“

Bearing with tapered bore and adapter sleeve

Bearing with cylindrical bore

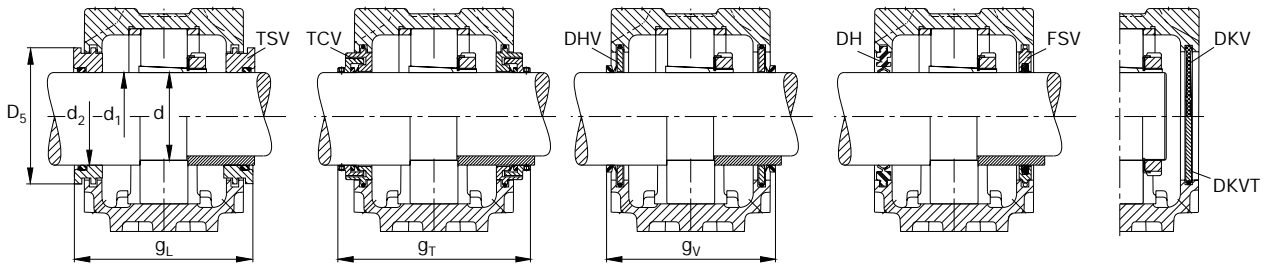

g_1	g_2	g_3	g_L	g_T	g_V	k	m_1	n_1	m_2	n_2	n_3	n_4	M DIN 931	M ₁ DIN 580	Mass ≈ kg
6	5.25	16	177.3	203 ¹⁾	168 ²⁾	70	261	80	300	66	99	142	M20	-	17

Required accessories

Adapter sleeve	Locknut	Lock washer	Locating ring 2 pieces	Two-lip seal	V-ring seal	Labyrinth ring with O ring	Felt seal	Combined seal	Cover**
FAG	FAG	FAG	FAG	FAG	FAG	FAG	FAG	FAG	FAG
H317.215 H2317.215			FRM180/14.5 FRM180/5	DH617 DH617	DHV617 DHV617	TSV617 TSV617	FSV617 FSV617	TCV617 TCV617	DKV180 DKV180
H317 H2317			FRM180/14.5 FRM180/5	DH617 DH617	DHV617 DHV617	TSV617 TSV617	FSV617 FSV617	TCV617 TCV617	DKV180 DKV180
H317.300 H2317.300			FRM180/14.5 FRM180/5	DH617 DH617	DHV617.300 DHV617.300	TSV617.300 TSV617.300	FSV617.300 FSV617.300	TCV617.300 TCV617.300	DKV180 DKV180
	KM17 KM17	MB17 MB17	FRM180/14.5 FRM180/5	DH317 DH317	DHV317 DHV317	TSV317 TSV317	FSV317 FSV317	TCV317 TCV317	DKV180 DKV180
H220.307 H320.307			FRM180/18 FRM180/12	DH520.307 DH520.307	DHV520.307 DHV520.307	TSV520.307 TSV520.307	FSV520.307 FSV520.307	TCV520.307 TCV520.307	DKV180 DKV180
H2320.307			FRM180/12 FRM180/4.85	DH520.307 DH520.307	DHV520.307 DHV520.307	TSV520.307 TSV520.307	FSV520.307 FSV520.307	TCV520.307 TCV520.307	DKV180 DKV180
H220.308 H320.308			FRM180/18 FRM180/12	DH520 DH520	DHV520 DHV520	TSV520.308 TSV520.308	FSV520.308 FSV520.308	TCV520.308 TCV520.308	DKV180 DKV180
H2320.308			FRM180/12 FRM180/4.85	DH520 DH520	DHV520 DHV520	TSV520.308 TSV520.308	FSV520.308 FSV520.308	TCV520.308 TCV520.308	DKV180 DKV180
H220 H320			FRM180/18 FRM180/12	DH520 DH520	DHV520 DHV520	TSV520 TSV520	FSV520 FSV520	TCV520 TCV520	DKV180 DKV180
H2320			FRM180/12 FRM180/4.85	DH520 DH520	DHV520 DHV520	TSV520 TSV520	FSV520 FSV520	TCV520 TCV520	DKV180 DKV180
H220.310 H320.310 H2320.310			FRM180/18 FRM180/12 FRM180/4.85	DH520.310 DH520.310 DH520.310	DHV520.310 DHV520.310 DHV520.310	TSV520.310 TSV520.310 TSV520.310	FSV520.310 FSV520.310 FSV520.310	TCV520.310 TCV520.310 TCV520.310	DKV180 DKV180 DKV180
H220.311 H320.311 H2320.311			FRM180/18 FRM180/12 FRM180/4.85	DH520.310 DH520.310 DH520.310	DHV520.311 DHV520.311 DHV520.311	TSV520.311 TSV520.311 TSV520.311	FSV520.311 FSV520.311 FSV520.311	TCV520.311 TCV520.311 TCV520.311	DKV180 DKV180 DKV180
	KM20 KM20 KM20	MB20 MB20 MB20	FRM180/18 FRM180/12 FRM180/4.85	DH220 DH220 DH220	DHV220 DHV220 DHV220	TSV220 TSV220 TSV220	FSV220 FSV220 FSV220		DKV180 DKV180 DKV180

¹⁾ $g_T = 202.5$ mm at TCV317
²⁾ $g_V = 167.5$ mm at DHV317
 $g_V = 170.5$ mm at DHV220

** for temperatures > 120 °C we recommend covers DKVT...

FAG plummer block housings, split

for bearings with cylindrical bore and
for bearings with tapered bore and adapter sleeve

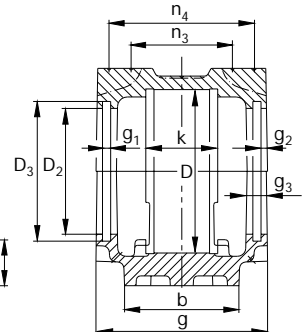
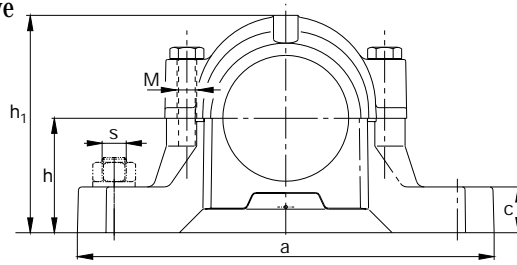
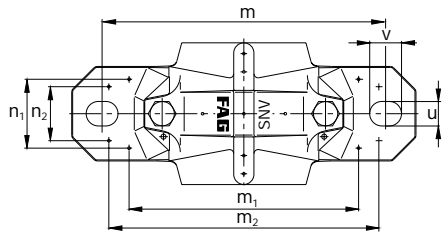

SNV190

Dimensions

D	a	b	c	g	h	m	s	u	v	h ₁	D ₂	D ₃	D ₅	
mm							mm	inch	mm					
190	380	110	40	155	112	320	M24	7/8	26	32	229	120	128.5	125.7

Shaft

d ₁	d	d ₂	Bearings which fit the housing						Split spherical roller bearing
mm	inch	mm	Codes according to DIN*						FAG
79.375	3 ¹ / ₈		1318K	20318K	21318K	2318K	22318K		
80			1318K	20318K	21318K	2318K	22318K		
80.963	3 ³ / ₁₆		1318K	20318K	21318K	2318K	22318K		
82.55	3 ¹ / ₄		1318K	20318K	21318K	2318K	22318K		
90		105 105	6318	1318	20318	21318	2318	22318	

* The order designation in the code according to DIN can be taken from the catalogue WL 41520EA „FAG Rolling Bearings“

Bearing with tapered bore and adapter sleeve

Bearing with cylindrical bore

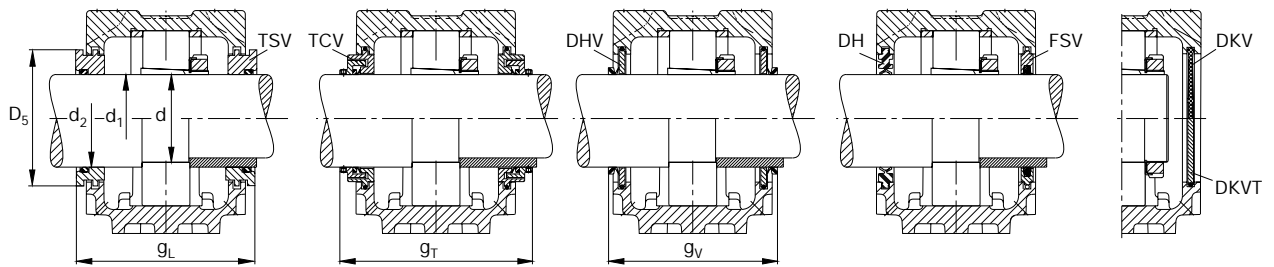

g_1	g_2	g_3	g_L	g_T	g_V	k	m_1	n_1	m_2	n_2	n_3	n_4	M DIN 931	M ₁ DIN 580	Mass ≈ kg
5	5.25	15	170.3	178	163 ¹⁾	74	271	81	300	66	99	137	M20	-	22

Required accessories

Adapter sleeve	Locknut	Lock washer	Locating ring 2 pieces	Two-lip seal	V-ring seal	Labyrinth ring with O ring	Felt seal	Combined seal	Cover**
FAG	FAG	FAG	FAG	FAG	FAG	FAG	FAG	FAG	FAG
H318.302 H2318.302			FRM190/15.5 FRM190/5	DH518 DH518	DHV518 DHV518	TSV518.302 TSV518.302	FSV518 FSV518	TCV518.302 TCV518.302	DKV160 DKV160
H318 H2318			FRM190/15.5 FRM190/5	DH518 DH518	DHV518 DHV518	TSV518 TSV518	FSV518 FSV518	TCV518 TCV518	DKV160 DKV160
H318.303 H2318.303			FRM190/15.5 FRM190/5	DH518 DH518	DHV518.303 DHV518.303	TSV518.303 TSV518.303	FSV518.303 FSV518.303	TCV518.303 TCV518.303	DKV160 DKV160
H318.304 H2318.304			FRM190/15.5 FRM190/5	DH518.304 DH518.304	DHV518.304 DHV518.304	TSV518.304 TSV518.304	FSV518.304 FSV518.304	TCV518.304 TCV518.304	DKV160 DKV160
	KM18 KM18	MB18 MB18	FRM190/15.5 FRM190/5	DH318 DH318	DHV318 DHV318	TSV318 TSV318	FSV318 FSV318		DKV160 DKV160

¹⁾ $g_V = 162.5$ mm at DHV318

** for temperatures > 120 °C we recommend covers DKVT...

FAG plummer block housings, split

for bearings with cylindrical bore and
for bearings with tapered bore and adapter sleeve

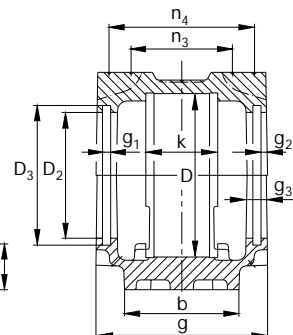
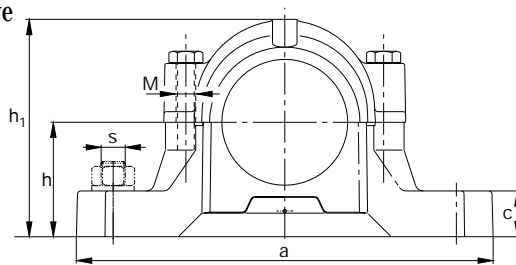
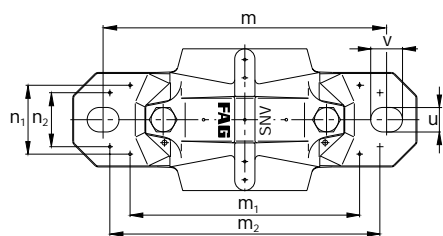

SNV200

Dimensions

D	a	b	c	g	h	m	s	u	v	h ₁	D ₂	D ₃	D ₅	
mm							mm	inch	mm					
200	410	120	45	175	125	350	M24	7/8	26	32	248	147.5	157.5	154.7

Shaft

d ₁ d		d ₂	Bearings which fit the housing					Split spherical roller bearing
mm	inch	mm	Codes according to DIN*					FAG
85			1319K	20319K	21319K	2319K	22319K	
85.725	3 ³ / ₈		1319K	20319K	21319K	2319K	22319K	
95		110 110	6319	1319	20319	21319	2319	22319
95.25	3 ³ / ₄		1222K	20222K			22222K	23222K
98.425	3 ⁷ / ₈		1222K	20222K			22222K	23222K
100			1222K	20222K			22222K	23222K 222SM100T
100.013	3 ¹⁵ / ₁₆		1222K	20222K			22222K	23222K
101.6	4		1222K	20222K			22222K	23222K 222S.400
110		125 125 125	6222	1222	20222		22222	23222

* The order designation in the code according to DIN can be taken from the catalogue WL 41520EA „FAG Rolling Bearings“

Bearing with tapered bore and adapter sleeve

Bearing with cylindrical bore

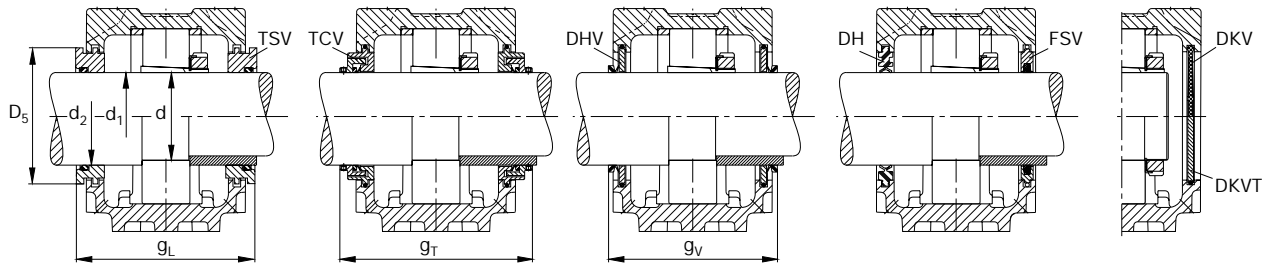

g_1	g_2	g_3	g_L	g_T	g_V	k	m_1	n_1	m_2	n_2	n_3	n_4	M DIN 931	M ₁ DIN 580	Mass ≈ kg
6	5.25	16	192.3 ¹⁾	218 ²⁾	183 ³⁾	80	291	88	320	74	111	157	M20	-	21

Required accessories

Adapter sleeve FAG	Locknut FAG	Lock washer FAG	Locating ring 2 pieces FAG	Two-lip seal FAG	V-ring seal FAG	Labyrinth ring with O ring FAG	Felt seal FAG	Combined seal FAG	Cover** FAG
H319 H2319			FRM200/17.5 FRM200/6.5	DH619 DH619	DHV619 DHV619	TSV619 TSV619	FSV619 FSV619	TCV619 TCV619	DKV200 DKV200
H319.306 H2319.306			FRM200/17.5 FRM200/6.5	DH619 DH619	DHV619 DHV619	TSV619.306 TSV619.306	FSV619 FSV619	TCV619.306 TCV619.306	DKV200 DKV200
	KM19 KM19	MB19 MB19	FRM200/17.5 FRM200/6.5	DH319 DH319	DHV319 DHV319	TSV319 TSV319	FSV319 FSV319	TCV319 TCV319	DKV200 DKV200
H222.312 H322.312 H2322.312			FRM200/21 FRM200/13.5 FRM200/5.1	DH522.312 DH522.312 DH522.312	DHV522.312 DHV522.312 DHV522.312	TSV522.312 TSV522.312 TSV522.312	FSV522.312 FSV522.312 FSV522.312	TCV522.312 TCV522.312 TCV522.312	DKV200 DKV200 DKV200
H222.314 H322.314 H2322.314			FRM200/21 FRM200/13.5 FRM200/5.1	DH522.314 DH522.314 DH522.314	DHV522.314 DHV522.314 DHV522.314	TSV522.314 TSV522.314 TSV522.314	FSV522.314 FSV522.314 FSV522.314	TCV522.314 TCV522.314 TCV522.314	DKV200 DKV200 DKV200
H222 H322			FRM200/21 FRM200/13.5 FRM200/13.5	DH522 DH522 DH522	DHV522 DHV522 DHV522	TSV522 TSV522 TSV522	FSV522 FSV522 FSV522	TCV522 TCV522 TCV522	DKV200 DKV200 DKV200
H2322			FRM200/5.1	DH522	DHV522	TSV522	FSV522	TCV522	DKV200
H222.315 H322.315 H2322.315			FRM200/21 FRM200/13.5 FRM200/5.1	DH522 DH522 DH522	DHV522 DHV522 DHV522	TSV522 TSV522 TSV522	FSV522 FSV522 FSV522	TCV522 TCV522 TCV522	DKV200 DKV200 DKV200
H222.400 H322.400			FRM200/21 FRM200/13.5 FRM200/13.5	DH522 DH522 DH522	DHV522.400 DHV522.400 DHV522.400	TSV522.400 TSV522.400 TSV522.400	FSV522.400 FSV522.400 FSV522.400	TCV522.400 TCV522.400 TCV522.400	DKV200 DKV200 DKV200
H2322.400			FRM200/5.1	DH522	DHV522.400	TSV522.400	FSV522.400	TCV522.400	DKV200
	KM22 KM22 KM22	MB22 MB22 MB22	FRM200/21 FRM200/13.5 FRM200/5.1	DH222 DH222 DH222	DHV222 DHV222 DHV222	TSV222 TSV222 TSV222	FSV222 FSV222 FSV222		DKV200 DKV200 DKV200

¹⁾ $g_L = 195.3$ mm at TSV522.312, TSV522.314, TSV522, TSV522.400 and TSV222

²⁾ $g_T = 217.5$ mm at TCV319

³⁾ $g_V = 185.5$ mm at DHV319 and DHV222

** for temperatures > 120 °C we recommend covers DKVT...

FAG plummer block housings, split

for bearings with cylindrical bore and
for bearings with tapered bore and adapter sleeve

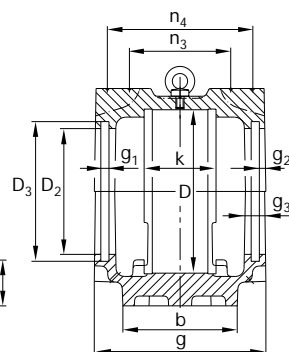
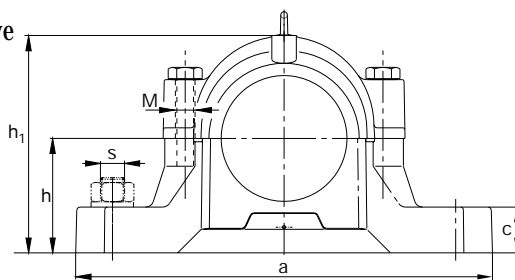
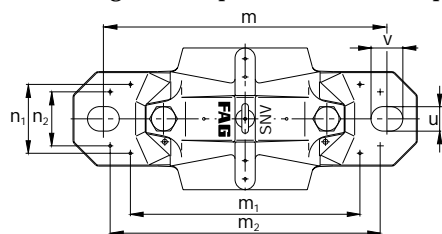

SNV215

Dimensions

D	a	b	c	g	h	m	s	u	v	h ₁	D ₂	D ₃	D ₅	
mm							mm	inch	mm					
215	410	120	45	180	140	350	M24	7/8	26	32	271	157.5	167.5	164.7

Shaft

d₁
d

d₂

Bearings which fit the housing

Unsplit bearings

Split spherical roller bearing

mm

inch

mm

Codes according to DIN*

FAG

87.313

3⁷/₁₆

1320K

20320K

21320K

2320K

22320K

88.9

3¹/₂

1320K

20320K

21320K

2320K

22320K

90

1320K

20320K

21320K

2320K

22320K

92.075

3⁵/₈

1320K

20320K

21320K

2320K

22320K

93.663

3¹¹/₁₆

1320K

20320K

21320K

2320K

22320K

100

115
115

6320

1320

20320

21320

2320

22320

106.363

4³/₁₆

20224K

22224K

23224K

222S.403

107.95

4¹/₄

20224K

22224K

23224K

110

20224K

22224K

23224K

222SM110T

120

135
135
135

6224

20224

22224

23224

* The order designation in the code according to DIN can be taken from the catalogue WL 41520EA „FAG Rolling Bearings“

Bearing with tapered bore and adapter sleeve

Bearing with cylindrical bore

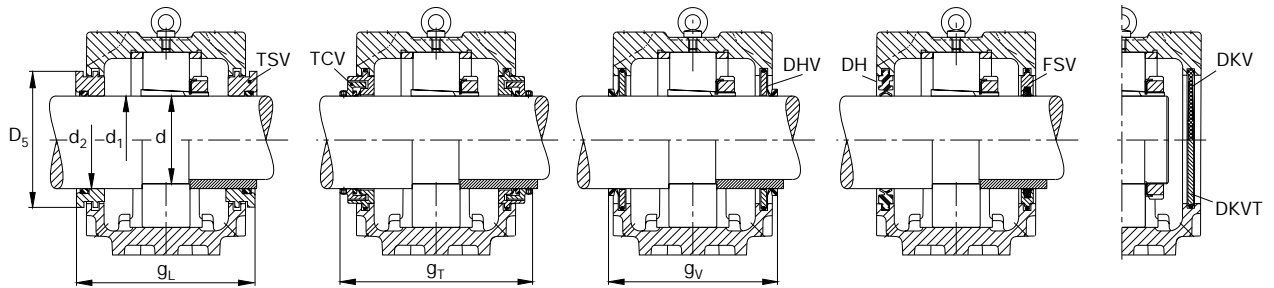

g_1	g_2	g_3	g_L	g_T	g_V	k	m_1	n_1	m_2	n_2	n_3	n_4	M DIN 931	M ₁ DIN 580	Mass ≈ kg
6	5.25	16	197.3 ¹⁾	224 ²⁾	188 ³⁾	86	297	91	330	74	117	162	M20	M10	24.5

Required accessories

Adapter sleeve	Locknut	Lock washer	Locating ring 2 pieces	Two-lip seal	V-ring seal	Labyrinth ring with O ring	Felt seal	Combined seal	Cover**
FAG	FAG	FAG	FAG	FAG	FAG	FAG	FAG	FAG	FAG
H320.307 H2320.307			FRM215/19.5 FRM215/6.5	DH620.307 DH620.307	DHV620.307 DHV620.307	TSV620.307 TSV620.307	FSV620.307 FSV620.307	TCV620.307 TCV620.307	DKV215 DKV215
H320.308 H2320.308			FRM215/19.5 FRM215/6.5	DH620 DH620	DHV620 DHV620	TSV620.308 TSV620.308	FSV620.308 FSV620.308	TCV620.308 TCV620.308	DKV215 DKV215
H320 H2320			FRM215/19.5 FRM215/6.5	DH620 DH620	DHV620 DHV620	TSV620 TSV620	FSV620 FSV620	TCV620 TCV620	DKV215 DKV215
H320.310 H2320.310			FRM215/19.5 FRM215/6.5	DH620.310 DH620.310	DHV620.310 DHV620.310	TSV620.310 TSV620.310	FSV620.310 FSV620.310	TCV620.310 TCV620.310	DKV215 DKV215
H320.311 H2320.311			FRM215/19.5 FRM215/6.5	DH620.310 DH620.310	DHV620.311 DHV620.311	TSV620.311 TSV620.311	FSV620.311 FSV620.311	TCV620.311 TCV620.311	DKV215 DKV215
	KM20 KM20	MB20 MB20	FRM215/19.5 FRM215/6.5	DH320 DH320	DHV320 DHV320	TSV320 TSV320	FSV320 FSV320	TCV320 TCV320	DKV215 DKV215
H3024.403 H3124.403			FRM215/23 FRM215/14	DH524.403 DH524.403	DHV524.403 DHV524.403	TSV524.403 TSV524.403	FSV524.403 FSV524.403	TCV524.403 TCV524.403	DKV215 DKV215
H2324.403			FRM215/14 FRM215/5	DH524.403 DH524.403	DHV524.403 DHV524.403	TSV524.403 TSV524.403	FSV524.403 FSV524.403	TCV524.403 TCV524.403	DKV215 DKV215
H3024.404 H3124.404 H2324.404			FRM215/23 FRM215/14 FRM215/5	DH524.403 DH524.403 DH524.403	DHV524.404 DHV524.404 DHV524.404	TSV524.404 TSV524.404 TSV524.404	FSV524.404 FSV524.404 FSV524.404	TCV524.404 TCV524.404 TCV524.404	DKV215 DKV215 DKV215
H3024 H3124			FRM215/23 FRM215/14	DH524 DH524	DHV524 DHV524	TSV524 TSV524	FSV524 FSV524	TCV524 TCV524	DKV215 DKV215
H2324			FRM215/14 FRM215/5	DH524 DH524	DHV524 DHV524	TSV524 TSV524	FSV524 FSV524	TCV524 TCV524	DKV215 DKV215
	KM24 KM24 KM24	MB24 MB24 MB24	FRM215/23 FRM215/14 FRM215/5	DH224 DH224 DH224	DHV224 DHV224 DHV224	TSV224 TSV224 TSV224	FSV224 FSV224 FSV224		DKV215 DKV215 DKV215

¹⁾ $g_L = 200.3$ mm at TSV524.403, TSV524.404, TSV524 and TSV224

²⁾ $g_T = 226.5$ mm at TCV320;

$g_T = 227$ mm at TCV524.403, TCV524.404 and TCV524

³⁾ $g_V = 190.5$ mm at DHV320, DHV224;

$g_V = 191$ mm at DHV524.403, DHV524.404 and DHV524

** for temperatures > 120 °C we recommend covers DKVT...

FAG plummer block housings, split

for bearings with cylindrical bore and
for bearings with tapered bore and adapter sleeve

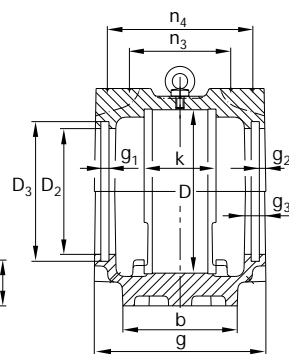
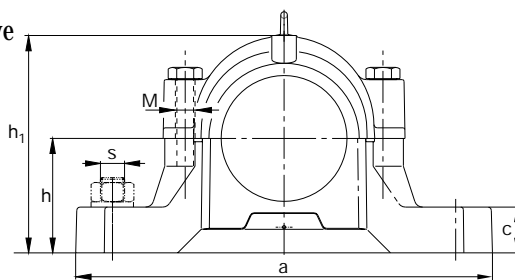
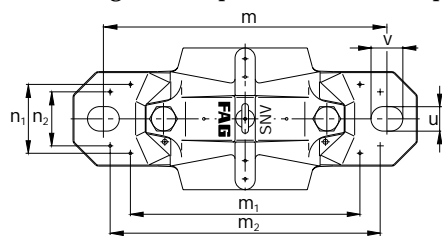

SNV230

Dimensions

D	a	b	c	g	h	m	s	u	v	h ₁	D ₂	D ₃	D ₅	
mm							mm	inch	mm					
230	445	130	50	190	150	380	M24	1	28	35	291	167.5	177.5	174.7

Shaft

d ₁	d	d ₂	Bearings which fit the housing		Split spherical roller bearing
mm	inch	mm	Unsplit bearings		FAG
			Codes according to DIN*		
112.713	4 ⁷ / ₁₆		20226K	22226K	222S.407
				23226K	
114.3	4 ¹ / ₂		20226K	22226K	222S.408
				23226K	
115			20226K	22226K	222SM115T
				23226K	
120.65	4 ³ / ₄		20226K	22226K	
				23226K	
130		145	6226	20226	
		145			22226
		145			23226

* The order designation in the code according to DIN can be taken from the catalogue WL 41520EA „FAG Rolling Bearings“

Bearing with tapered bore and adapter sleeve

Bearing with cylindrical bore

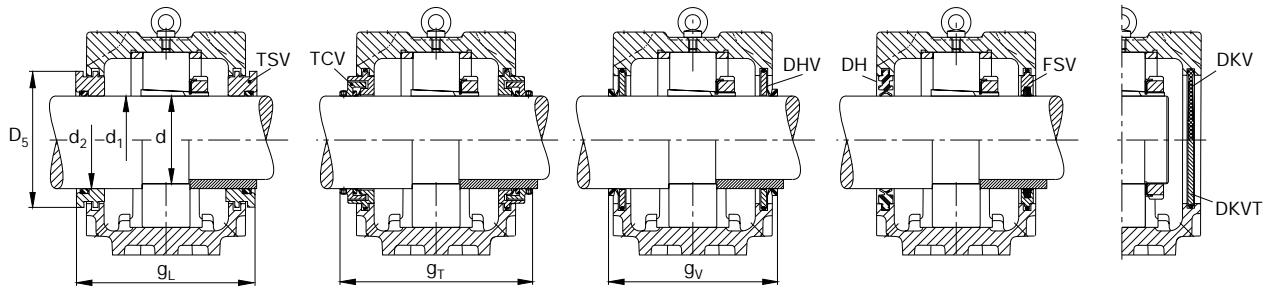

g_1	g_2	g_3	g_L	g_T	g_v	k	m_1	n_1	m_2	n_2	n_3	n_4	M DIN 931	M ₁ DIN 580	Mass ≈ kg
6	6.25	18	208.3	235	199 ¹⁾	90	325	97	370	80	122	170	M24	M10	30

Required accessories

Adapter sleeve FAG	Locknut FAG	Lock washer FAG	Locating ring 2 pieces FAG	Two-lip seal FAG	V-ring seal FAG	Labyrinth ring with O ring FAG	Felt seal FAG	Combined seal FAG	Cover** FAG
H3026.407			FRM230/25	DH526.407	DHV526.407	TSV526.407	FSV526.407	TCV526.407	DKV230
H3126.407			FRM230/13	DH526.407	DHV526.407	TSV526.407	FSV526.407	TCV526.407	DKV230
H2326.407			FRM230/5	DH526.407	DHV526.407	TSV526.407	FSV526.407	TCV526.407	DKV230
H3026.408			FRM230/25	DH526	DHV526	TSV526.408	FSV526	TCV526	DKV230
H3126.408			FRM230/13	DH526	DHV526	TSV526.408	FSV526	TCV526	DKV230
H2326.408			FRM230/5	DH526	DHV526	TSV526.408	FSV526	TCV526	DKV230
H3026			FRM230/25	DH526	DHV526	TSV526	FSV526	TCV526	DKV230
H3126			FRM230/13	DH526	DHV526	TSV526	FSV526	TCV526	DKV230
H2326			FRM230/5	DH526	DHV526	TSV526	FSV526	TCV526	DKV230
H3026.412			FRM230/25	DH526.412	DHV526.412	TSV526.412	FSV526.412	TCV526.412	DKV230
H3126.412			FRM230/13	DH526.412	DHV526.412	TSV526.412	FSV526.412	TCV526.412	DKV230
H2326.412			FRM230/5	DH526.412	DHV526.412	TSV526.412	FSV526.412	TCV526.412	DKV230
	KM26	MB26	FRM230/25	DH226	DHV226	TSV226	FSV226		DKV230
	KM26	MB26	FRM230/13	DH226	DHV226	TSV226	FSV226		DKV230
	KM26	MB26	FRM230/5	DH226	DHV226	TSV226	FSV226		DKV230

¹⁾ $g_v = 198.5$ mm at DHV226

** for temperatures > 120 °C we recommend covers DKVT...

FAG plummer block housings, split

for bearings with cylindrical bore and
for bearings with tapered bore and adapter sleeve

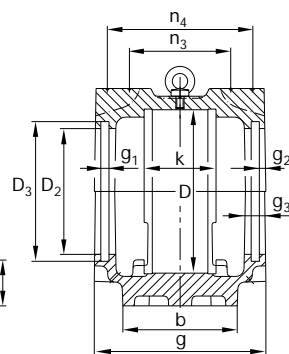
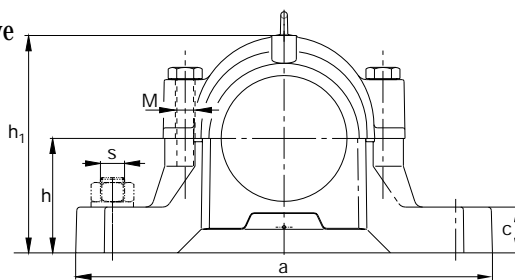
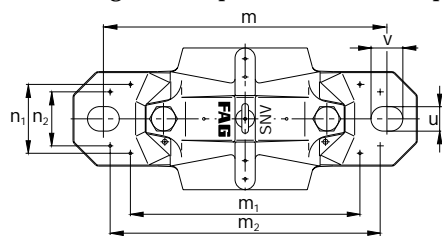

SNV240

Dimensions

D	a	b	c	g	h	m	s	u	v	h ₁	D ₂	D ₃	D ₅	
mm							mm	inch	mm					
240	450	130	50	185	150	390	M24	1	28	35	298	147.5	157.5	154.7

Shaft

d ₁	d	d ₂	Bearings which fit the housing			Split spherical roller bearing
mm	inch	mm	Codes according to DIN*			FAG
95.25	3 ³ / ₄		20322K	21322K	22322K	
98.425	3 ⁷ / ₈		20322K	21322K	22322K	
100			20322K	21322K	22322K	
100.013	3 ¹⁵ / ₁₆		20322K	21322K	22322K	
101.6	4		20322K	21322K	22322K	
110		125 125	6322	20322	21322	22322

* The order designation in the code according to DIN can be taken from the catalogue WL 41520EA „FAG Rolling Bearings“

Bearing with tapered bore and adapter sleeve

Bearing with cylindrical bore

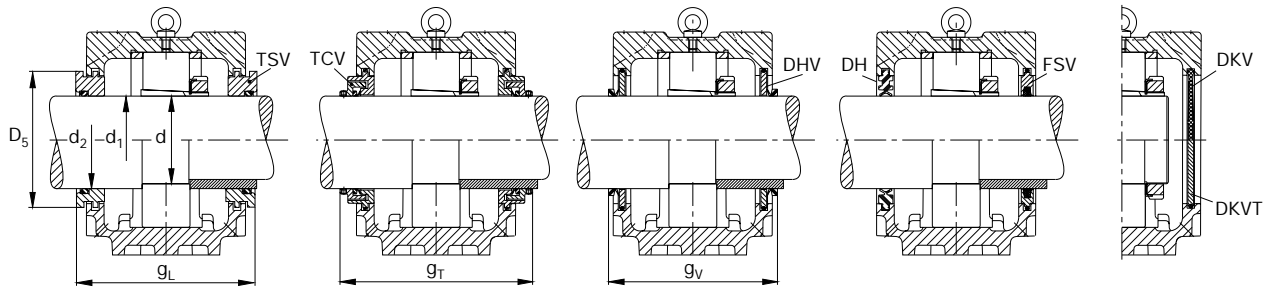

g_1	g_2	g_3	g_L	g_T	g_V	k	m_1	n_1	m_2	n_2	n_3	n_4	M DIN 931	M ₁ DIN 580	Mass ≈ kg
6	6.25	18	203.3	226	191 ¹⁾	90	328	96	370	80	120	165	M24	M10	32

Required accessories

Adapter sleeve	Locknut	Lock washer	Locating ring 2 pieces	Two-lip seal	V-ring seal	Labyrinth ring with O ring	Felt seal	Combined seal	Cover**
FAG	FAG	FAG	FAG	FAG	FAG	FAG	FAG	FAG	FAG
H322.312 H2322.312			FRM240/20 FRM240/5	DH522.312 DH522.312	DHV522.312 DHV522.312	TSV522.312 TSV522.312	FSV522.312 FSV522.312	TCV522.312 TCV522.312	DKV200 DKV200
H322.314 H2322.314			FRM240/20 FRM240/5	DH522.314 DH522.314	DHV522.314 DHV522.314	TSV522.314 TSV522.314	FSV522.314 FSV522.314	TCV522.314 TCV522.314	DKV200 DKV200
H322 H2322			FRM240/20 FRM240/5	DH522 DH522	DHV522 DHV522	TSV522 TSV522	FSV522 FSV522	TCV522 TCV522	DKV200 DKV200
H322.315 H2322.315			FRM240/20 FRM240/5	DH522 DH522	DHV522 DHV522	TSV522 TSV522	FSV522 FSV522	TCV522 TCV522	DKV200 DKV200
H322.400 H2322.400			FRM240/20 FRM240/5	DH522 DH522	DHV522.400 DHV522.400	TSV522.400 TSV522.400	FSV522.400 FSV522.400	TCV522.400 TCV522.400	DKV200 DKV200
	KM22 KM22	MB22 MB22	FRM240/20 FRM240/5	DH222 DH222	DHV222 DHV222	TSV222 TSV222	FSV222 FSV222		DKV200 DKV200

¹⁾ $g_V = 193.5$ mm at DHV222

** for temperatures > 120 °C we recommend covers DKVT...

FAG plummer block housings, split

for bearings with cylindrical bore and
for bearings with tapered bore and adapter sleeve

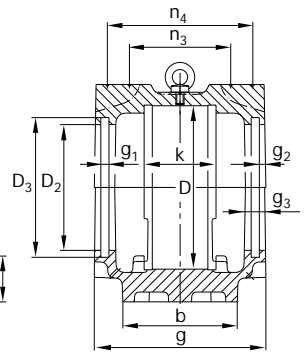
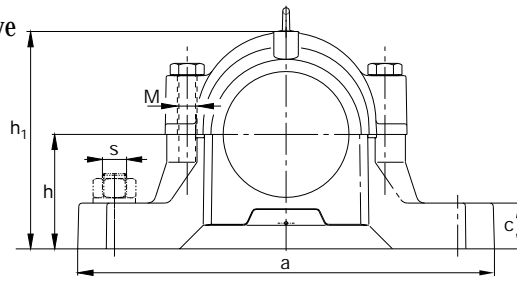
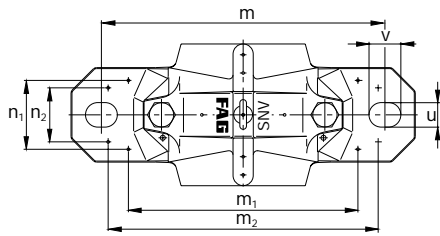

SNV250

Dimensions

D	a	b	c	g	h	m	s	u	v	h ₁	D ₂	D ₃	D ₅	
mm							mm	inch	mm					
250	500	150	50	200	150	420	M30	1 ¹ / ₄	35	42	304	177.5	187.5	184.2

Shaft

d ₁	d	d ₂	Bearings which fit the housing		Split spherical roller bearing
mm	inch	mm	Codes according to DIN*		FAG
125			20228K		22228K 23228K 222SM125T
125.413	4 ¹⁵ / ₁₆		20228K		22228K 23228K
127	5		20228K		22228K 23228K 222S.500
140		155 155 155	6228	20228	22228 23228

* The order designation in the code according to DIN can be taken from the catalogue WL 41520EA „FAG Rolling Bearings“

Bearing with tapered bore and adapter sleeve

Bearing with cylindrical bore

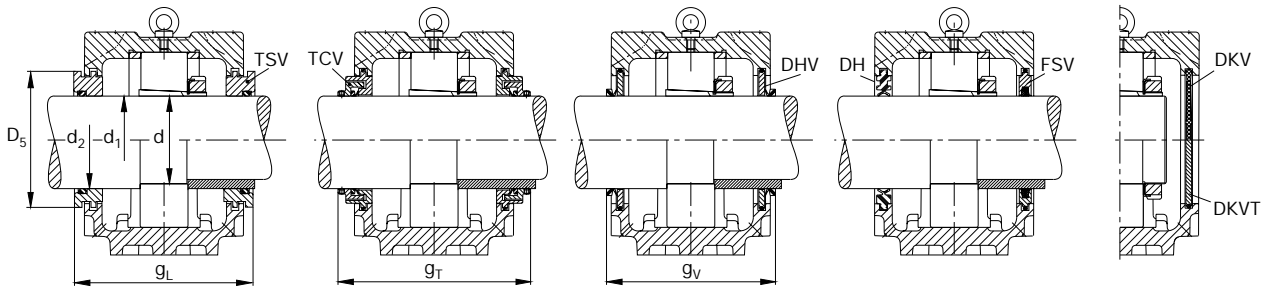

g_1	g_2	g_3	g_L	g_T	g_v	k	m_1	n_1	m_2	n_2	n_3	n_4	M DIN 931	M ₁ DIN 580	Mass ≈ kg
6	6.25	18	218.3	245	209 ¹⁾	98	342	109	400	92	131	180	M24	M10	38

Required accessories

Adapter sleeve	Locknut	Lock washer	Locating ring 2 pieces	Two-lip seal	V-ring seal	Labyrinth ring with O ring	Felt seal	Combined seal	Cover**
FAG	FAG	FAG	FAG	FAG	FAG	FAG	FAG	FAG	FAG
H3028			FRM250/28	DH528	DHV528	TSV528	FSV528	TCV528	DKV250
H3128			FRM250/15	DH528	DHV528	TSV528	FSV528	TCV528	DKV250
H2328			FRM250/5	DH528	DHV528	TSV528	FSV528	TCV528	DKV250
H3028.415			FRM250/28	DH528	DHV528	TSV528.415	FSV528	TCV528.415	DKV250
H3128.415			FRM250/15	DH528	DHV528	TSV528.415	FSV528	TCV528.415	DKV250
H2328.415			FRM250/5	DH528	DHV528	TSV528.415	FSV528	TCV528.415	DKV250
H3028.500			FRM250/28	DH528	DHV528.500	TSV528.500	FSV528.500	TCV528.500	DKV250
H3128.500			FRM250/15	DH528	DHV528.500	TSV528.500	FSV528.500	TCV528.500	DKV250
H2328.500			FRM250/5	DH528	DHV528.500	TSV528.500	FSV528.500	TCV528.500	DKV250
	KM28	MB28	FRM250/28	DH228	DHV228	TSV228	FSV228		DKV250
	KM28	MB28	FRM250/15	DH228	DHV228	TSV228	FSV228		DKV250
	KM28	MB28	FRM250/5	DH228	DHV228	TSV228	FSV228		DKV250

¹⁾ $g_v = 211.5$ mm at DHV228

** for temperatures > 120 °C we recommend covers DKVT...

FAG plummer block housings, split

for bearings with cylindrical bore and
for bearings with tapered bore and adapter sleeve

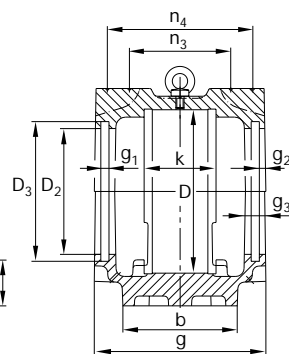
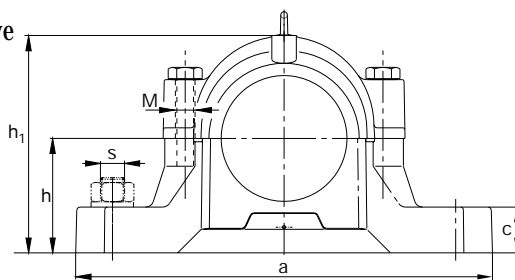
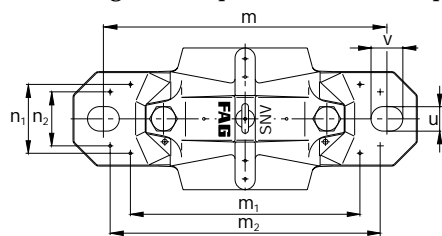

SNV260

Dimensions

D	a	b	c	g	h	m	s	u	v	h ₁	D ₂	D ₃	D ₅	
mm							mm	inch	mm					
260	530	160	60	190	160	450	M30	1 ¹ / ₄	35	42	321	157.5	167.5	164.7

Shaft

d ₁	d	d ₂	Bearings which fit the housing		Split spherical roller bearing
mm	inch	mm	Codes according to DIN*		FAG
106.363	4 ³ / ₁₆			20324K	22324K
107.95	4 ¹ / ₄			20324K	22324K
110				20324K	22324K
120		135 135	6324	20324	22324

* The order designation in the code according to DIN can be taken from the catalogue WL 41520EA „FAG Rolling Bearings“

Bearing with tapered bore and adapter sleeve

Bearing with cylindrical bore

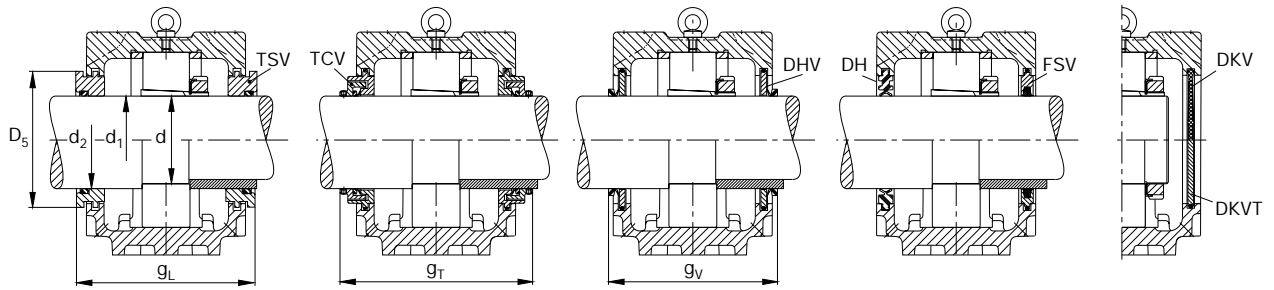

g_1	g_2	g_3	g_L	g_T	g_V	k	m_1	n_1	m_2	n_2	n_3	n_4	M DIN 931	M ₁ DIN 580	Mass ≈ kg
6	6.25	18	208.3	235	199 ¹⁾	96	372	113	430	100	125	170	M24	M10	48

Required accessories

Adapter sleeve	Locknut	Lock washer	Locating ring 2 pieces	Two-lip seal	V-ring seal	Labyrinth ring with O ring	Felt seal	Combined seal	Cover**
FAG	FAG	FAG	FAG	FAG	FAG	FAG	FAG	FAG	FAG
H3124.403 H2324.403			FRM260/20.5 FRM260/5	DH524.403 DH524.403	DHV524.403 DHV524.403	TSV524.403 TSV524.403	FSV524.403 FSV524.403	TCV524.403 TCV524.403	DKV215 DKV215
H3124.404 H2324.404			FRM260/20.5 FRM260/5	DH524.403 DH524.403	DHV524.404 DHV524.404	TSV524.404 TSV524.404	FSV524.404 FSV524.404	TCV524.404 TCV524.404	DKV215 DKV215
H3124 H2324			FRM260/20.5 FRM260/5	DH524 DH524	DHV524 DHV524	TSV524 TSV524	FSV524 FSV524	TCV524 TCV524	DKV215 DKV215
	KM24 KM24	MB24 MB24	FRM260/20.5 FRM260/5	DH224 DH224	DHV224 DHV224	TSV224 TSV224	FSV224 FSV224		DKV215 DKV215

¹⁾ $g_V = 198.5$ mm at DHV224

** for temperatures > 120 °C we recommend covers DKVT...

FAG plummer block housings, split

for bearings with cylindrical bore and
for bearings with tapered bore and adapter sleeve

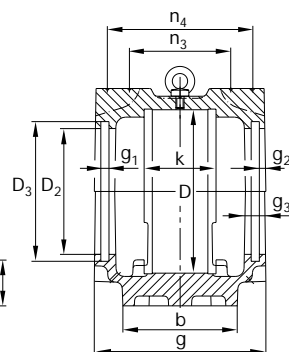
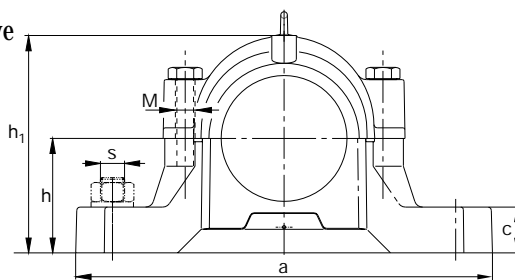
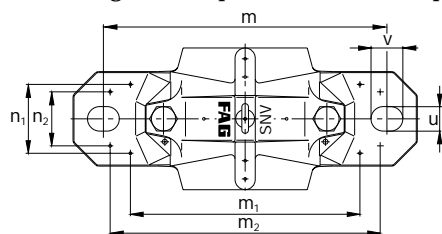

SNV270

Dimensions

D	a	b	c	g	h	m	s	u	v	h ₁	D ₂	D ₃	D ₅	
mm							mm	inch	mm					
270	530	160	60	215	160	450	M30	1 ¹ / ₄	35	42	328	192.5	202.5	199.2

Shaft

d ₁	d	d ₂	Bearings which fit the housing		Split spherical roller bearing
mm	inch	mm	Codes according to DIN*		FAG
131.763	5 ³ / ₁₆		20230K	22230K	222S.503
				23230K	
133.35	5 ¹ / ₄		20230K	22230K	23230K
135			20230K	22230K	222SM135T
				23230K	
150		165 165 165	6230	20230	22230 23230

* The order designation in the code according to DIN can be taken from the catalogue WL 41520EA „FAG Rolling Bearings“

Bearing with tapered bore and adapter sleeve

Bearing with cylindrical bore

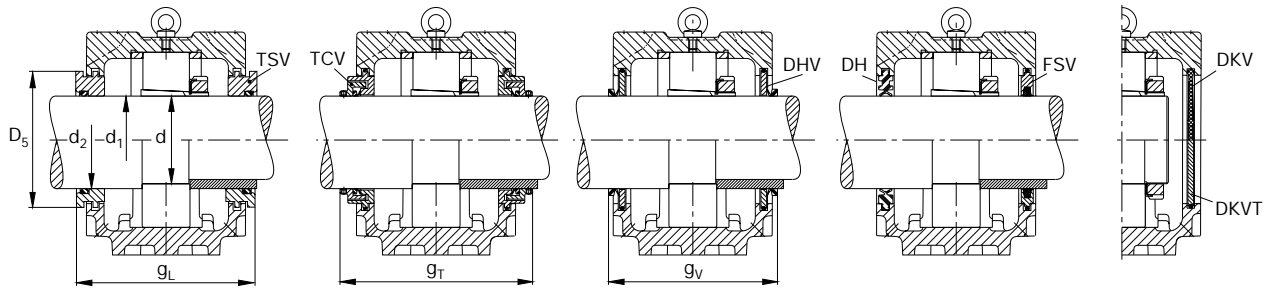

g_1	g_2	g_3	g_L	g_T	g_V	k	m_1	n_1	m_2	n_2	n_3	n_4	M DIN 931	M ₁ DIN 580	Mass ≈ kg
6	6.25	18	233.3	260	224 ¹⁾	106	372	116	430	100	143	195	M24	M10	45.5

Required accessories

Adapter sleeve	Locknut	Lock washer	Locating ring 2 pieces	Two-lip seal	V-ring seal	Labyrinth ring with O ring	Felt seal	Combined seal	Cover**
FAG	FAG	FAG	FAG	FAG	FAG	FAG	FAG	FAG	FAG
H3030.503			FRM270/30.5	DH530.503	DHV530.503	TSV530.503	FSV530.503	TCV530.503	DKV270
H3130.503			FRM270/16.5	DH530.503	DHV530.503	TSV530.503	FSV530.503	TCV530.503	DKV270
H2330.503			FRM270/5	DH530.503	DHV530.503	TSV530.503	FSV530.503	TCV530.503	DKV270
H3030.504			FRM270/30.5	DH530.504	DHV530.504	TSV530.504	FSV530.504	TCV530.504	DKV270
H3130.504			FRM270/16.5	DH530.504	DHV530.504	TSV530.504	FSV530.504	TCV530.504	DKV270
H2330.504			FRM270/5	DH530.504	DHV530.504	TSV530.504	FSV530.504	TCV530.504	DKV270
H3030			FRM270/30.5	DH530	DHV530	TSV530	FSV530	TCV530	DKV270
H3130			FRM270/16.5	DH530	DHV530	TSV530	FSV530	TCV530	DKV270
H2330			FRM270/5	DH530	DHV530	TSV530	FSV530	TCV530	DKV270
	KM30	MB30	FRM270/30.5	DH230	DHV230	TSV230	FSV230		DKV270
	KM30	MB30	FRM270/16.5	DH230	DHV230	TSV230	FSV230		DKV270
	KM30	MB30	FRM270/5	DH230	DHV230	TSV230	FSV230		DKV270

¹⁾ $g_V = 228.5$ mm at DHV230

** for temperatures > 120 °C we recommend covers DKVT...

FAG plummer block housings, split

for bearings with cylindrical bore and
for bearings with tapered bore and adapter sleeve

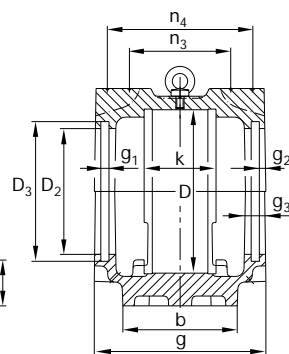
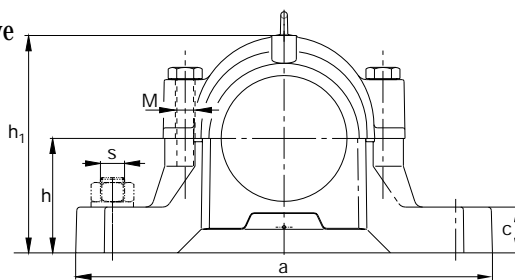
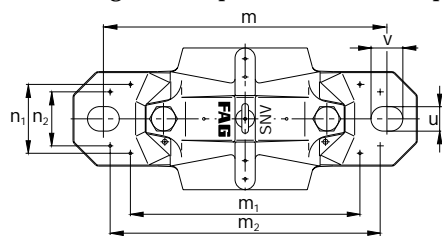

SNV280

Dimensions

D	a	b	c	g	h	m	s	u	v	h ₁	D ₂	D ₃	D ₅	
mm							mm	inch	mm					
280	550	160	60	205	170	470	M30	1 ¹ / ₄	35	42	344	167.5	177.5	174.7

Shaft

d ₁	d	d ₂	Bearings which fit the housing		Split spherical roller bearing
mm	inch	mm	Codes according to DIN*		FAG
112.713	4 ⁷ / ₁₆			20326K	22326K
114.3	4 ¹ / ₂			20326K	22326K
115				20326K	22326K
120.65	4 ³ / ₄			20326K	22326K
130		150 150	6326	20326	22326

* The order designation in the code according to DIN can be taken from the catalogue WL 41520EA „FAG Rolling Bearings“

Bearing with tapered bore and adapter sleeve

Bearing with cylindrical bore

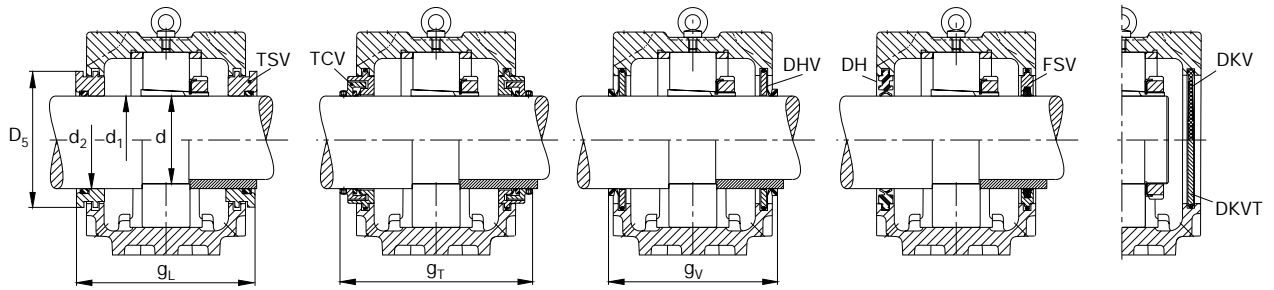

g_1	g_2	g_3	g_L	g_T	g_V	k	m_1	n_1	m_2	n_2	n_3	n_4	M DIN 931	M ₁ DIN 580	Mass ≈ kg
6	6.25	18	223.3	250	214 ¹⁾	103	392	114	450	100	136	185	M24	M10	55

Required accessories

Adapter sleeve	Locknut	Lock washer	Locating ring 2 pieces	Two-lip seal	V-ring seal	Labyrinth ring with O ring	Felt seal	Combined seal	Cover**
FAG	FAG	FAG	FAG	FAG	FAG	FAG	FAG	FAG	FAG
H3126.407 H2326.407			FRM280/22.5 FRM280/5	DH526.407 DH526.407	DHV526.407 DHV526.407	TSV526.407 TSV526.407	FSV526.407 FSV526.407	TCV526.407 TCV526.407	DKV230 DKV230
H3126.408 H2326.408			FRM280/22.5 FRM280/5	DH526 DH526	DHV526 DHV526	TSV526.408 TSV526.408	FSV526 FSV526	TCV526 TCV526	DKV230 DKV230
H3126 H2326			FRM280/22.5 FRM280/5	DH526 DH526	DHV526 DHV526	TSV526 TSV526	FSV526 FSV526	TCV526 TCV526	DKV230 DKV230
H3126.412 H2326.412			FRM280/22.5 FRM280/5	DH526.412 DH526.412	DHV526.412 DHV526.412	TSV526.412 TSV526.412	FSV526.412 FSV526.412	TCV526.412 TCV526.412	DKV230 DKV230
	KM26 KM26	MB26 MB26	FRM280/22.5 FRM280/5	DH326 DH326	DHV326 DHV326	TSV326 TSV326	FSV326 FSV326		DKV230 DKV230

¹⁾ $g_V = 213.5$ mm at DHV326

** for temperatures > 120 °C we recommend covers DKVT...

FAG plummer block housings, split

for bearings with cylindrical bore and
for bearings with tapered bore and adapter sleeve

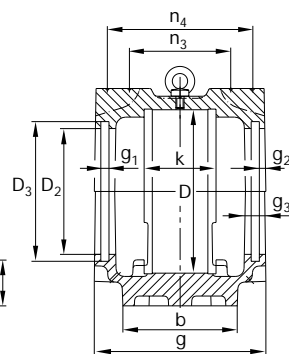
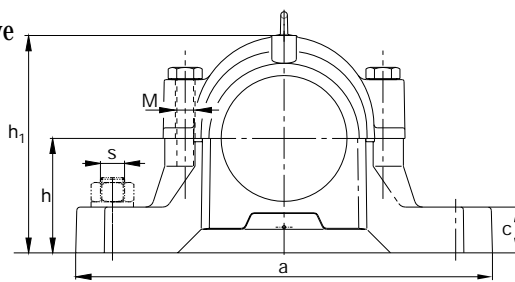
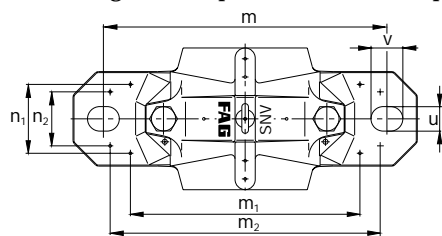

SNV290

Dimensions

D	a	b	c	g	h	m	s	u	v	h ₁	D ₂	D ₃	D ₅	
mm							mm	inch	mm					
290	550	160	60	225	170	470	M30	1 ¹ / ₄	35	42	351	202.5	212.5	209.2

Shaft

d ₁	d	d ₂	Bearings which fit the housing		Split spherical roller bearing
mm	inch	mm	Codes according to DIN*		FAG
138.113	5 ⁷ / ₁₆		20232K	22232K	222S.507
				23232K	
139.7	5 ¹ / ₂		20232K	22232K	23232K
140			20232K	22232K	222SM140T
				23232K	
160		175	6232	20232	22232
		175			23232
		175			

* The order designation in the code according to DIN can be taken from the catalogue WL 41520EA „FAG Rolling Bearings“

Bearing with tapered bore and adapter sleeve

Bearing with cylindrical bore

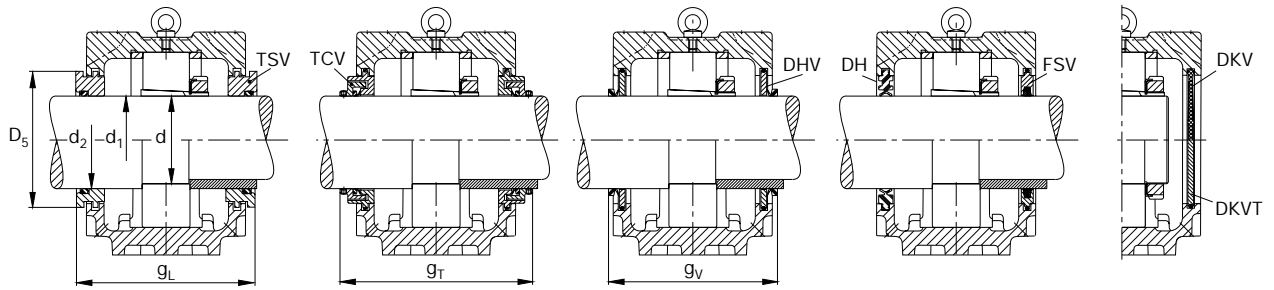

g_1	g_2	g_3	g_L	g_T	g_V	k	m_1	n_1	m_2	n_2	n_3	n_4	M DIN 931	M ₁ DIN 580	Mass ≈ kg
6	6.25	18	243.3	270	234 ¹⁾	114	392	120	450	100	152	205	M24	M10	53.8

Required accessories

Adapter sleeve	Locknut	Lock washer	Locating ring 2 pieces	Two-lip seal	V-ring seal	Labyrinth ring with O ring	Felt seal	Combined seal	Cover**
FAG	FAG	FAG	FAG	FAG	FAG	FAG	FAG	FAG	FAG
H3032.507			FRM290/33	DH532.507	DHV532.507	TSV532.507	FSV532.507	TCV532.507	DKV290
H3132.507			FRM290/17	DH532.507	DHV532.507	TSV532.507	FSV532.507	TCV532.507	DKV290
H2332.507			FRM290/5	DH532.507	DHV532.507	TSV532.507	FSV532.507	TCV532.507	DKV290
H3032.508			FRM290/33	DH532	DHV532	TSV532	FSV532	TCV532	DKV290
H3132.508			FRM290/17	DH532	DHV532	TSV532	FSV532	TCV532	DKV290
H2332.508			FRM290/5	DH532	DHV532	TSV532	FSV532	TCV532	DKV290
H3032			FRM290/33	DH532	DHV532	TSV532	FSV532	TCV532	DKV290
H3132			FRM290/17	DH532	DHV532	TSV532	FSV532	TCV532	DKV290
H2332			FRM290/5	DH532	DHV532	TSV532	FSV532	TCV532	DKV290
	KM32	MB32	FRM290/33	DH232	DHV232	TSV232	FSV232		DKV290
	KM32	MB32	FRM290/17	DH232	DHV232	TSV232	FSV232		DKV290
	KM32	MB32	FRM290/5	DH232	DHV232	TSV232	FSV232		DKV290

¹⁾ $g_V = 236.5$ mm at DHV232

** for temperatures > 120 °C we recommend covers DKVT...

FAG plummer block housings, split

for bearings with cylindrical bore and
for bearings with tapered bore and adapter sleeve

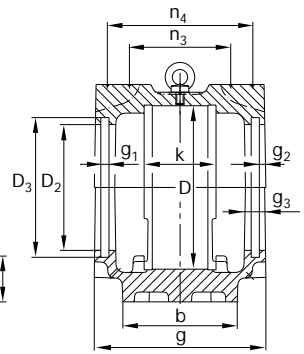
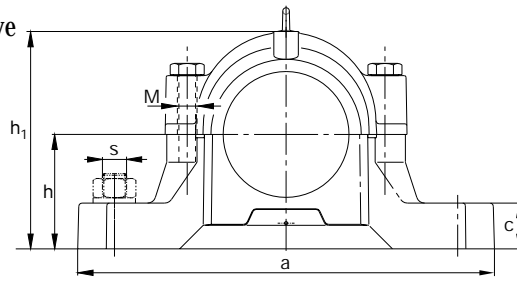
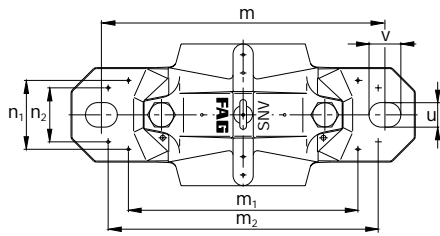

SNV300

Dimensions

D	a	b	c	g	h	m	s	u	v	h ₁	D ₂	D ₃	D ₅	
mm							mm	inch	mm					
300	620	170	65	215	180	520	M30	1 ¹ / ₄	35	42	366	177.5	187.5	184.2

Shaft

d ₁	d	d ₂	Bearings which fit the housing		Split spherical roller bearing
mm	inch	mm	Codes according to DIN*		FAG
125				20328K	22328K
125.413	4 ¹⁵ / ₁₆			20328K	22328K
127	5			20328K	22328K
140		160 160	6328	20328	22328

* The order designation in the code according to DIN can be taken from the catalogue WL 41520EA „FAG Rolling Bearings“

Bearing with tapered bore and adapter sleeve

Bearing with cylindrical bore

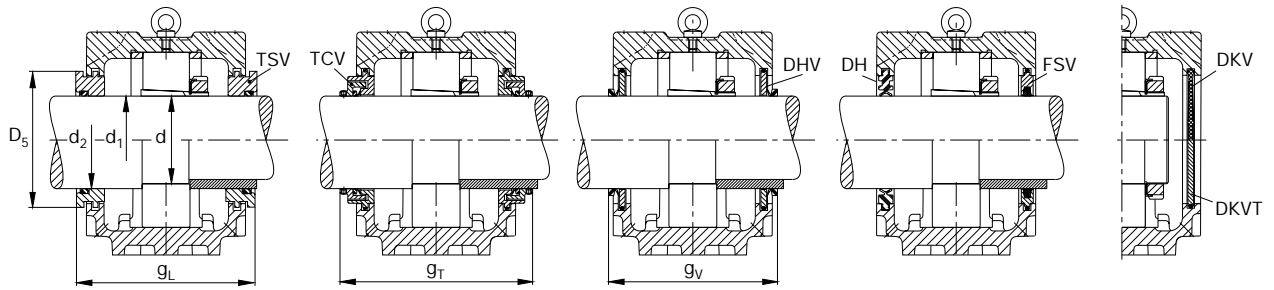

g_1	g_2	g_3	g_L	g_T	g_V	k	m_1	n_1	m_2	n_2	n_3	n_4	M DIN 931	M ₁ DIN 580	Mass ≈ kg
6	6.25	18	233.3	260	224 ¹⁾	112	442	123	500	100	146	195	M24	M10	70

Required accessories

Adapter sleeve	Locknut	Lock washer	Locating ring 2 pieces	Two-lip seal	V-ring seal	Labyrinth ring with O ring	Felt seal	Combined seal	Cover**
FAG	FAG	FAG	FAG	FAG	FAG	FAG	FAG	FAG	FAG
H3128 H2328			FRM300/25 FRM300/5	DH528 DH528	DHV528 DHV528	TSV528 TSV528	FSV528 FSV528	TCV528 TCV528	DKV250 DKV250
H3128.415 H2328.415			FRM300/25 FRM300/5	DH528 DH528	DHV528 DHV528	TSV528.415 TSV528.415	FSV528 FSV528	TCV528.415 TCV528.415	DKV250 DKV250
H3128.500 H2328.500			FRM300/25 FRM300/5	DH528 DH528	DHV528.500 DHV528.500	TSV528.500 TSV528.500	FSV528.500 FSV528.500	TCV528.500 TCV528.500	DKV250 DKV250
	KM28 KM28	MB28 MB28	FRM300/25 FRM300/5	DH328 DH328	DHV328 DHV328	TSV328 TSV328	FSV328 FSV328		DKV250 DKV250

¹⁾ $g_V = 226.5$ mm at DHV328

** for temperatures > 120 °C we recommend covers DKVT...

FAG plummer block housings, split

for bearings with cylindrical bore and
for bearings with tapered bore and adapter sleeve

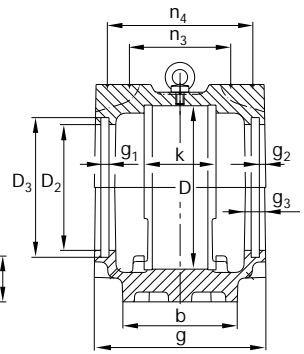
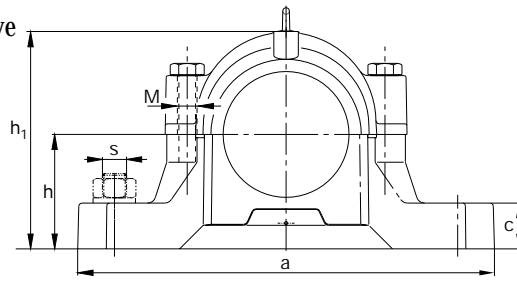
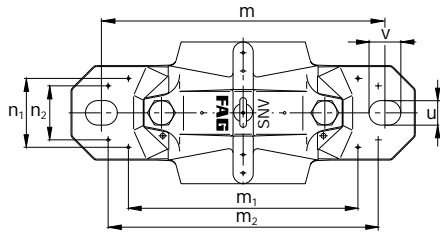

SNV320

Dimensions

D	a	b	c	g	h	m	s	u	v	h ₁	D ₂	D ₃	D ₅	
mm							mm	inch	mm					
320	650	180	65	225	190	560	M30	1 ¹ / ₄	35	42	386	192.5	202.5	199.2

Shaft

d ₁	d	d ₂	Bearings which fit the housing		Split spherical roller bearing
mm	inch	mm	Codes according to DIN*		FAG
131.763	5³/₁₆			20330K	22330K
133.35	5¹/₄			20330K	22330K
135				20330K	22330K
150		170 170	6330	20330	22330

* The order designation in the code according to DIN can be taken from the catalogue WL 41520EA „FAG Rolling Bearings“

Bearing with tapered bore and adapter sleeve

Bearing with cylindrical bore

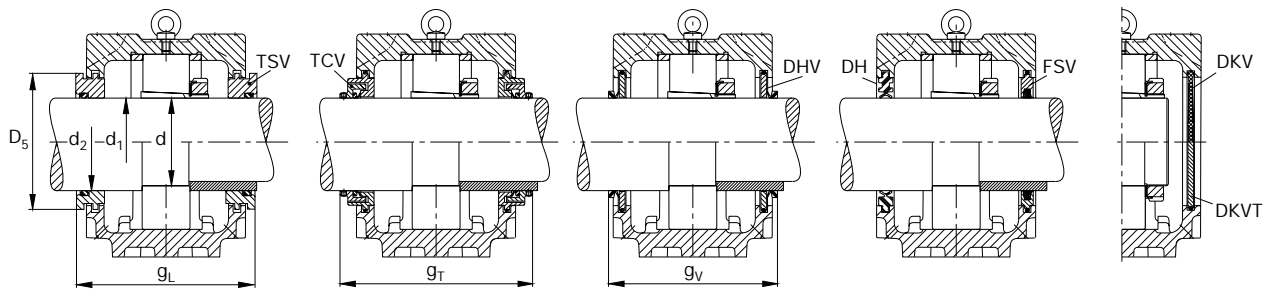

g_1	g_2	g_3	g_L	g_T	g_v	k	m_1	n_1	m_2	n_2	n_3	n_4	M DIN 931	M ₁ DIN 580	Mass ≈ kg
6	6.25	18	243.3	270	234 ¹⁾	118	482	130	540	100	154	205	M24	M10	95

Required accessories

Adapter sleeve	Locknut	Lock washer	Locating ring 2 pieces	Two-lip seal	V-ring seal	Labyrinth ring with O ring	Felt seal	Combined seal	Cover**
FAG	FAG	FAG	FAG	FAG	FAG	FAG	FAG	FAG	FAG
H3130.503 H2330.503			FRM320/26.5 FRM320/5	DH530.503 DH530.503	DHV530.503 DHV530.503	TSV530.503 TSV530.503	FSV530.503 FSV530.503	TCV530.503 TCV530.503	DKV270 DKV270
H3130.504 H2330.504			FRM320/26.5 FRM320/5	DH530.504 DH530.504	DHV530.504 DHV530.504	TSV530.504 TSV530.504	FSV530.504 FSV530.504	TCV530.504 TCV530.504	DKV270 DKV270
H3130 H2330			FRM320/26.5 FRM320/5	DH530 DH530	DHV530 DHV530	TSV530 TSV530	FSV530 FSV530	TCV530 TCV530	DKV270 DKV270
	KM30 KM30	MB30 MB30	FRM320/26.5 FRM320/5	DH330 DH330	DHV330 DHV330	TSV330 TSV330	FSV330 FSV330		DKV270 DKV270

¹⁾ $g_v = 236.5$ mm at DHV330

** for temperatures > 120 °C we recommend covers DKVT...

FAG plummer block housings, split

for bearings with cylindrical bore and
for bearings with tapered bore and adapter sleeve

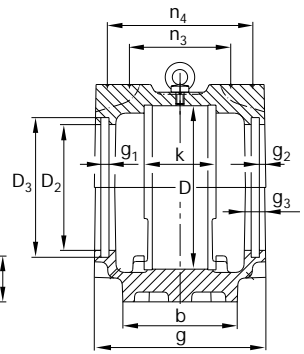
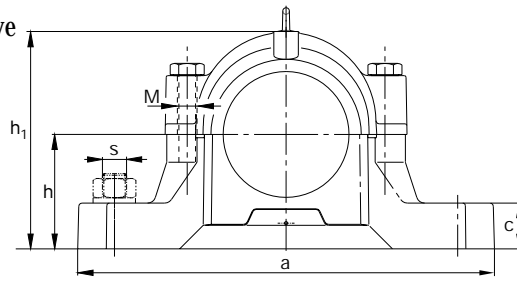
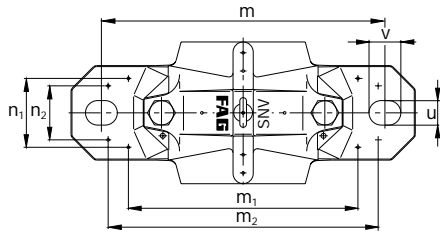

SNV340

Dimensions

D	a	b	c	g	h	m	s	u	v	h ₁	D ₂	D ₃	D ₅	
mm							mm	inch	mm					
340	680	190	70	235	200	580	M36	1 1/2	42	50	406	202.5	212.5	209.2

Shaft

d ₁	d	d ₂	Bearings which fit the housing	
mm	inch	mm	Unsplit bearings	Split spherical roller bearing
			Codes according to DIN*	FAG
138.113	5 ⁷ / ₁₆		20332K	22332K
139.7	5 ¹ / ₂		20332K	22332K
140			20332K	22332K
160		180 180	6332 20332	22332

* The order designation in the code according to DIN can be taken from the catalogue WL 41520EA „FAG Rolling Bearings“

Bearing with tapered bore and adapter sleeve

Bearing with cylindrical bore

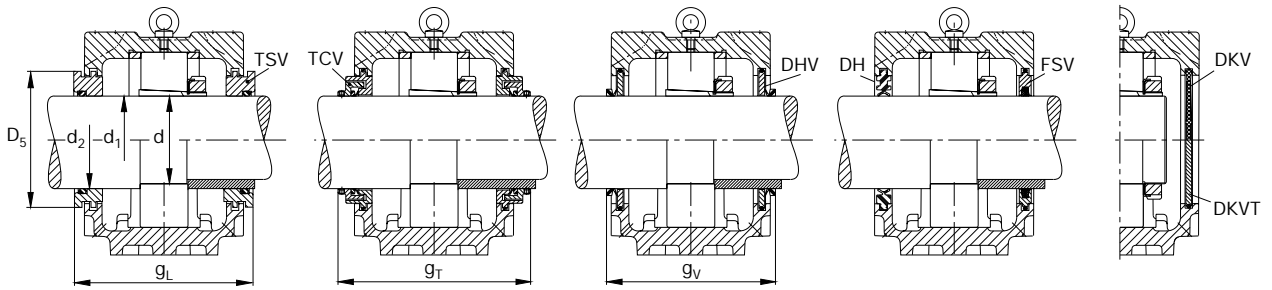

g_1	g_2	g_3	g_L	g_T	g_V	k	m_1	n_1	m_2	n_2	n_3	n_4	M DIN 931	M ₁ DIN 580	Mass ≈ kg
6	6.25	18	253.3	298	244 ¹⁾	124	489	138	570	100	162	215	M30	M10	115

Required accessories

Adapter sleeve	Locknut	Lock washer	Locating ring 2 pieces	Two-lip seal	V-ring seal	Labyrinth ring with O ring	Felt seal	Combined seal	Cover**
FAG	FAG	FAG	FAG	FAG	FAG	FAG	FAG	FAG	FAG
H3132.507 H2332.507			FRM340/28 FRM340/5	DH532.507 DH532.507	DHV532.507 DHV532.507	TSV532.507 TSV532.507	FSV532.507 FSV532.507	TCV532.507 TCV532.507	DKV290 DKV290
H3132.508 H2332.508			FRM340/28 FRM340/5	DH532 DH532	DHV532 DHV532	TSV532 TSV532	FSV532 FSV532	TCV532 TCV532	DKV290 DKV290
H3132 H2332			FRM340/28 FRM340/5	DH532 DH532	DHV532 DHV532	TSV532 TSV532	FSV532 FSV532	TCV532 TCV532	DKV290 DKV290
	KM32 KM32	MB32 MB32	FRM340/28 FRM340/5	DH332 DH332	DHV332 DHV332	TSV332 TSV332	FSV332 FSV332		DKV290 DKV290

¹⁾ $g_V = 246.5$ mm at DHV332

** for temperatures > 120 °C we recommend covers DKVT...

Notes

Notes

FAG Kugelfischer AG & Co. KG
Industrial Bearings and Services

Postfach 1260
D-97419 Schweinfurt
Telefon +49 9721 91-0
Telefax +49 9721 91-3435
E-mail: gehaeuse@fag.de
www.fag.com

Every care has been taken to ensure the correctness of the information contained in this publication but no liability can be accepted for any errors or omissions. We reserve the right to make changes in the interest of technical progress.
© by FAG 2003. This publication or parts thereof may not be reproduced without our permission.